

Industrial Mercmaster™ LED Low Profile Series Luminaires

Standard or with Emergency Battery Backup
Ordinary Locations

NEC/CEC Standard Model: Type 3R, 4, 4X | IP66 | IP67 | Suitable for Use in Wet Locations | Marine Outside Type (Salt Water) ⌘
NEC/CEC Emergency Battery Backup Model: Type 3R, 4, 4X | IP66 | IP67 | Suitable for Use in Wet Locations | Marine Outside Type (Salt Water) ⌘
IECEE CB Standard Model: IK08
Notable: American Bureau of Shipping (ABS) Certified | International Dark Sky (IDA) Approved (Standard Model Only) | 10G Vibration

Applications

- Enclosed and gasketed fixtures suitable for use in:
 - A wide range of harsh industrial environments
 - Marine and wet locations
 - Areas of low clearance, low ceiling heights or where fixture weights must be minimized
 - Areas where dust, water, dirt and rough usage are a problem
- Typical applications include:
 - Walkways and catwalks
 - Stairwells
 - Tunnels
 - Pipe racks
 - Processing areas
 - Hydrogen and Biofuels plants
 - LNG (Liquid Natural Gas) plants

Features

- All Models:
 - Compact light weight low profile design is suited for low mounting heights.
 - Four light output levels provide up to 5500 lumens. 7500 lumens.
- | Standard Mode | | |
|------------------|----------------|---------|
| Nominal Lumens ① | HID Equivalent | Model |
| 3500 | 70-100W | IMLLED2 |
| 4750 | 100-150W | IMLLED3 |
| 6000 | 150-175W | IMLLED4 |
| 7460 | 175-250W | IMLLED7 |
- Choice of color temperature (CCT): 5000K cool white (70 CRI min), 4000K neutral white (80 CRI min), 3000K warm white (80 CRI min), 1800K high pressure sodium (70 CRI min), or yellow amber.
 - Seven standard mounting hood designs allow for mounting in any location. Uses same mounting hoods as Mercmaster™ III HID, Mercmaster™ Premium LED and Mercmaster™ Generation 3.
 - Retrofit adapters for Crouse Hinds™ †, Mercmaster™ II HID, and Killark™ ‡ available. See Mercmaster™ Adapters.
 - Watertight Pendant Hood available to address water ingress into luminaire via conduit.
 - Hinge has high lip for added safety during installation and servicing. Hinge and bolt construction assures 360° compression at all points on fixture housing gasket for positive sealing. Swing away design of captive bolt and nut simplifies servicing.
 - Rugged housing with superior thermal design translates to long luminaire life.
 - Reliable heat transfer via the cast, epoxy powder coat aluminum housing (heatsink). Provides maximum heat dissipation from the LED assembly to the outside environment.
 - Mounting Hood and Globe Gaskets are silicone rubber to seal out moisture, dirt and dust; stays flexible and withstands extreme temperatures. Closure design assures uniform gasket compression.
 - Spring-loaded screw-type terminal block can accept 0.14 - 6 mm² (26 - 10 AWG) wire.



KPA + IMLLED + VPGL-GLASS



KPCH + IMLLED + LPG-R55

— Reported L70:

+25 °C (+77 °F)	Reported	> 60000
	Calculated	> 200000
+65 °C (+149 °F)	Reported	> 60000
	Calculated	> 200000

— Photometric data and electronic drawings available upon request.

• Standard Model:

— Customize to the application requirements with four different field replaceable globe options: clear and diffused polycarbonate, clear glass, or prismatic glass refractor.

— Voltages:

- BU: 100-277 Vac or 125-300 Vdc
- BH: 347-480 Vac
- B2: 24-48 Vdc

— Ambient Temperature:

- BU and B2: -40 °C to +65 °C (-40 °F to +149 °F) standard; -50 °C to +65 °C (-58 °F to +149 °F) cold temperature option
- BH: -40 °C to +65 °C (-40 °F to +149 °F) standard

— Field replaceable globes and LED driver.

— Standard 6 kV/3 kA surge protection.

• Emergency Battery Backup Model:

- Provides up to 1700 lumens of illumination for 90 minutes or 1000 lumens of illumination for 180 minutes of emergency lighting with clear lens.
- Functional diagnostic test self-initiates every 14 days after initial start up.
- Duration test is automatically performed once per year.
- Green and Red LED lamps indicate charging status and provide fault warning.
- Simple quick disconnect connector disconnects power between LEDs and battery management module to allow for easy maintenance.
- Customize to the application requirements with three different field replaceable globe options: clear and diffused polycarbonate, or clear glass.
- Ambient Temperature: BU: -20 °C to +55 °C (-4 °F to +131 °F).
- Field replaceable globes, battery management module (BMM), battery pack and LED driver.

① Nominal lumen value for 5000K, clear glass globe Type V Wide. Detailed lumen information is provided in the "Lumen Output (Efficacy)" tables.

‡ Killark is a registered trademark of Killark Manufacturing Company.

† Crouse-Hinds is a registered trademark of Cooper Industries, Inc., a wholly owned subsidiary of the Eaton Corporation plc.

⌘ Use of fuse voids Marine Outside Type (Salt Water) rating.

Industrial Mercmaster™ LED Low Profile Series Luminaires

Standard or with Emergency Battery Backup

Ordinary Locations

NEC/CEC Standard Model: Type 3R, 4, 4X | IP66 | IP67 | Suitable for Use in Wet Locations | Marine Outside Type (Salt Water) ⌘
 NEC/CEC Emergency Battery Backup Model: Type 3R, 4, 4X | IP66 | IP67 | Suitable for Use in Wet Locations | Marine Outside Type (Salt Water) ⌘
 IEC EE CB Standard Model: IK08
 Notable: American Bureau of Shipping (ABS) Certified | International Dark Sky (IDA) Approved (Standard Model Only) | 10G Vibration

Warranty ⌘

- 10 year standard warranty.

Controls

- Dimming:
 - Industrial Mercmaster LED Low Profile Luminaires offer a two-wire, 0-10V variable dimming input port for controlling the light output:
 - Standard operating temperature models: from 10% to 100% of the rated lumen output.
 - Cold temperature option models: from 0% to 100% of the rated lumen output.
 - 24-48 Vdc models: from 0 to 100% of the rated lumen output.
- Group Lighting Controls:
 - Simplify installation of energy saving lighting controls.
 - Control up to 10 luminaires over a distance of 60 meters (200 ft) with Industrial Mercmaster Connect LED integrated dimming controller.
 - Daisy chain the luminaires on the same circuit breaker by wiring the 0-10V dimming leads to the Connected luminaire. Enable the Industrial Mercmaster Connect's advanced capabilities to extend daylight harvesting (adjustable output), motion sensing (up to 12 meters [40 ft]) and scheduling features (up to 4 times period per day) with the group of lights.
 - Optionally commission and monitor the group of lights remotely via our Plantweb Insight™ Connected Lighting App.

Options

- All Models:
 - Globe guard available, *purchase separately*
 - Safety cable available, *purchase separately*
 - For custom paint colors, contact your Appleton Sales Representative. Minimum quantity applies.
- Standard Model:
 - Refractor guard available, *purchase separately*
 - All NEC/CEC Certified Industrial Mercmaster Luminaires have provision for fusing; add suffix –F to the catalog number, see *Catalog Numbering Guide for details*.
 - All Industrial Mercmaster LED Low Profile Luminaires are available with a cold temperature option; add suffix –C to the catalog number, see *Catalog Numbering Guide for details*.
 - Photocontrols are available and are configured to your operating voltage. Add suffix -1 for 120V, -2 for 208-277V.
 - Colored Glass globes available, purchase separately: Amber (VPGLGLASSAM), Blue (VPGLGLASSBL), Red (VPGLGLASSRE), Green (VPGLGLASSGR)

Standard Materials

- Mounting hoods and housing: cast copperfree (4/10 of 1% max.) aluminum
- Gaskets: silicone rubber
- All hardware and catch assemblies: stainless steel
- Globe: polycarbonate or glass
- Refractor: heat-resistant prismatic glass
- Globe guard, short refractor guard and safety cable: stainless steel wire

Standard Finishes

- Mounting hoods, driver housing and glass refractor guard: gray epoxy powder coat finish, electrostatically applied for complete uniform protection.

NEC/CEC Certifications and Compliances

- Standard Model:
 - UL Standard: UL 1598; UL 8750; UL 1598A, UL 50E
 - CSA Standard: C22.2 No. 250.0; C22.2 No. 250.13; C22.2 No. 0; C22.2 No. 94.2
 - NEMA ANSI/IEC Standard: 60529
 - cCSAus: 164460, Certificate Number: 70129363
- Emergency Battery Backup Model:
 - UL Standard: UL 1598; UL 8750; UL 924; UL 50E
 - CSA Standard: C22.2 No. 250.0; C22.2 No. 250.13; C22.2 No. 0; C22.2 No. 94.2; C22.2 No. 141
 - cCSAus: 164460, Certificate Number: 70172444

IECEE CB Certificates and Compliances:

- Standard Model:
 - IEC 60598-1, IEC 60598-2-1
 - IEC EE CB Certificates: 64460-80075816
 - Photobiological Safety, IEC 62778 and IEC 62471: RG0

NOM: Norma Oficial Mexicana:

- Standard Model:
 - NOM-003-SCFI-2014 (NMX-J-307-ANCE-2017)
 - NOM Certificate: ULM-NOM-06823

ABS Certifications

- Standard Model: 18-HS1714308-PDA
- Emergency Battery Backup Model: 22-2207901-PDA

International Dark-Sky Association

- Standard Model:
 - IDA Dark-Sky Approved when ordering [I]MLED[A/B/C/D/R/W] [2/3/4]W[P/D/G]5Bxxx with MMVISOR accessory.

Chile Zoning Compliant

- Zone A Compliant when ordering [I]MLEDx xxA[P/D/G]5Bxxx
- Zone B Compliant when ordering [I]MLEDx xx[S/A][P/D/G]5Bxxx

DesignLights™ Consortium

- Check DLC QPL for current list of products.

Related Products

- Mercmaster Connect LED Luminaires
- Mercmaster LED Generation 3 Series Luminaires
- Mercmaster LED Low Profile Luminaires
- Industrial Mercmaster Connect LED Luminaires
- Industrial Mercmaster LED Generation 3 Series Luminaires

⌘ For warranty details go to www.appleton.emerson.com.

Industrial Mercmaster™ LED Low Profile Series Luminaires

Standard or with Emergency Battery Backup
Ordinary Locations

NEC/CEC Standard Model: Type 3R, 4, 4X | IP66 | IP67 | Suitable for Use in Wet Locations | Marine Outside Type (Salt Water) ⌘
NEC/CEC Emergency Battery Backup Model: Type 3R, 4, 4X | IP66 | IP67 | Suitable for Use in Wet Locations | Marine Outside Type (Salt Water) ⌘
IECEE CB Standard Model: IK08
Notable: American Bureau of Shipping (ABS) Certified | International Dark Sky (IDA) Approved (Standard Model Only) | 10G Vibration

Illustrated Features — All Models



Group Lighting Controls:
Control up to 10 luminaires over a distance of 60 meters (200 ft) with Industrial Mercmaster Connect LED integrated dimming controller by daisy chaining the dimming leads from the group of lights.



Bulkhead Application:
When using the surface/ceiling mount, the Industrial Mercmaster LED Low Profile can be mounted up to 90 degrees with no dust accumulation.



Watertight Pendant Hood:
Provides protection against water ingress in the conduit utilizing an IP68 cord grip with 3 wire holes 4 mm (0.157") in diameter.



Latch Assembly and Hinge:
Captive, stainless steel latch assembly (bolt and nut) closes securely while providing resistance to corrosive atmospheres. Swing-away design simplifies wiring and installation. Extra high hinge provides additional protection against accidental driver housing disengagement during installation or maintenance.



Field Replaceable Parts:
Replacement glass and polycarbonate globes and drivers available — allowing for easy maintenance.



Visor (optional):
When installed correctly, maintains light distribution type and ensures luminaire meets dark sky requirements.



Retrofit Adapters (optional):
Seamlessly retrofit to pre-existing Crouse Hinds™ †, Mercmaster II, and Killark™ † HID mounting hoods.



Safety Cable (optional): Safety cable is slipped around the housing through retention points that are casted in. Safety cable has built in loops combined with a locking carabiner to allow for a quick and secure installation.

Illustrated Features — Standard Model



Photocell (optional):
Factory Installed in the Mounting Hood. Available for all fixtures except cone and ceiling mount. Provides continuous ON-OFF dusk-to-dawn control.



Fuses (optional):
Fuses factory installed in luminaire housing.

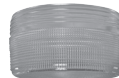

Prismatic Refractors:
Heat-resistant refractor threads directly into fixture housing and seal against a high-temperature silicone rubber gasket.



Colored Glass Globes (optional):
Amber, Blue, Red, Green are available and field installable for applications that require specific sections to be highlighted.

Illustrated Features — Emergency Battery Backup Model



Quick Disconnect:
Simple quick disconnect connector disconnects power between LEDs and battery management module to allow for easy maintenance.

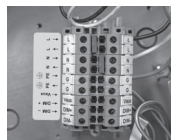

Field Changeable Emergency Setting:
Allows user to switch the battery system setting as needed in the field to go from 90 to 180 min or 180 to 90 min battery.



Battery (optional):
Field replaceable battery pack and battery management module — allowing for easy maintenance.

⌘ Use of fuse voids Marine Outside Type (Salt Water) rating.

† Killark is a registered trademark of Hubbell Incorporated.

† Crouse-Hinds is a registered trademark of Cooper Industries, Inc., a wholly owned subsidiary of the Eaton Corporation plc.

Industrial Mercmaster™ LED Low Profile Series Luminaires

Standard

Ordinary Locations

NEC/CEC Standard Model: Type 3R, 4, 4X | IP66 | IP67 | Suitable for Use in Wet Locations | Marine Outside Type (Salt Water) ⌘

IECEE CB Standard Model: IK08

Notable: American Bureau of Shipping (ABS) Certified | International Dark Sky (IDA) Approved (Standard Model Only) | 10G Vibration

Family Tree — Industrial Mercmaster™ LED Low Profile Series Luminaires — Standard Model

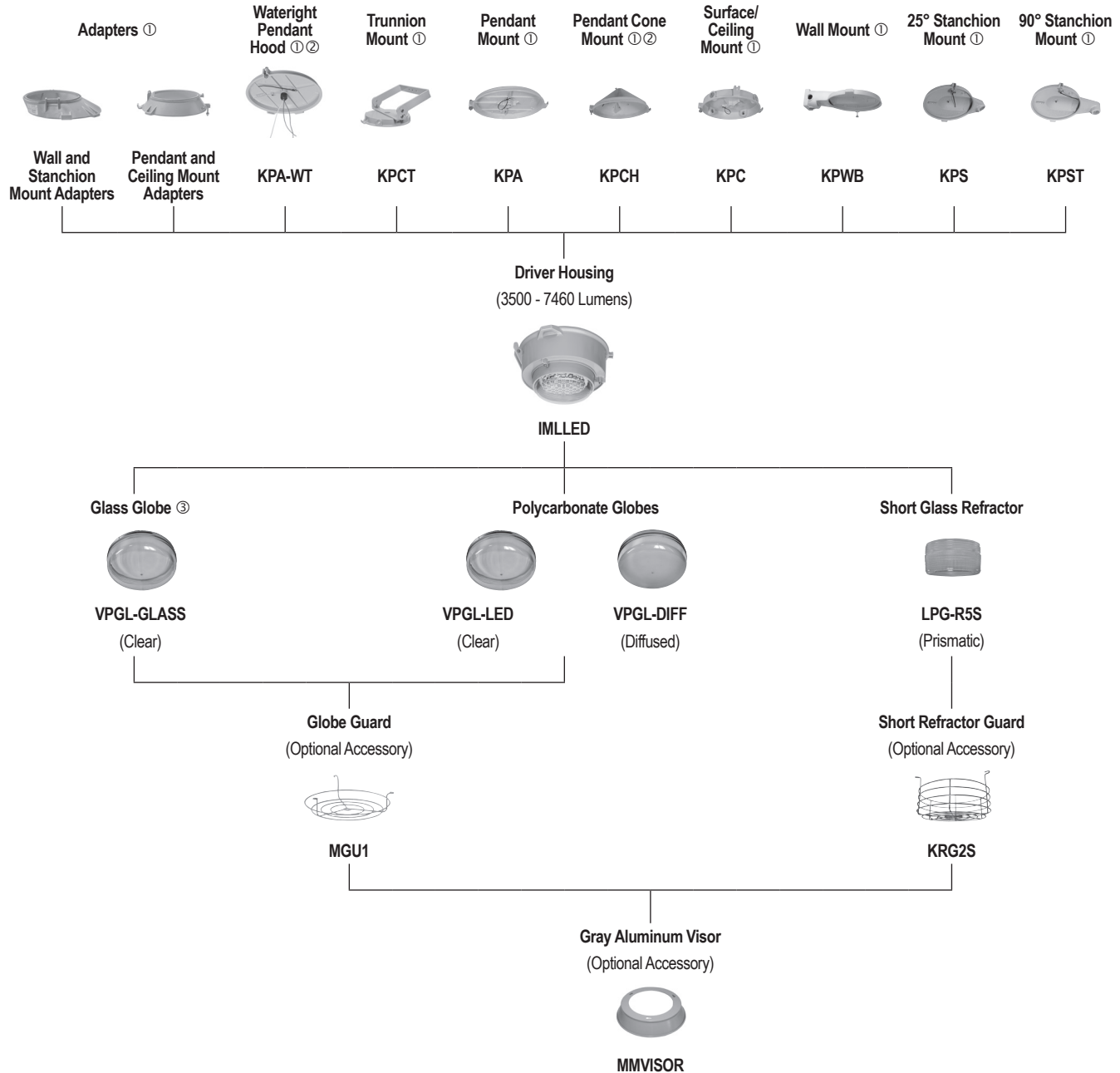

① See Mounting Hood Adapters table for part numbers.

② Certified for cCSAus only.

③ Colored glass globes can be ordered separately, see Accessories and Replacement Parts table for more details.

⌘ Use of fuse voids Marine Outside Type (Salt Water) rating.

Industrial Mercmaster™ LED Low Profile Series Luminaires

With Emergency Battery Backup
Ordinary Locations

NEC/CEC Emergency Battery Backup Model: Type 3R, 4, 4X | IP66 | IP67 | Suitable for Use in Wet Locations | Marine Outside Type (Salt Water) ⌘
Notable: American Bureau of Shipping (ABS) Certified | 10G Vibration

Family Tree — Industrial Mercmaster™ LED Low Profile Series Luminaires — Emergency Battery Backup Model

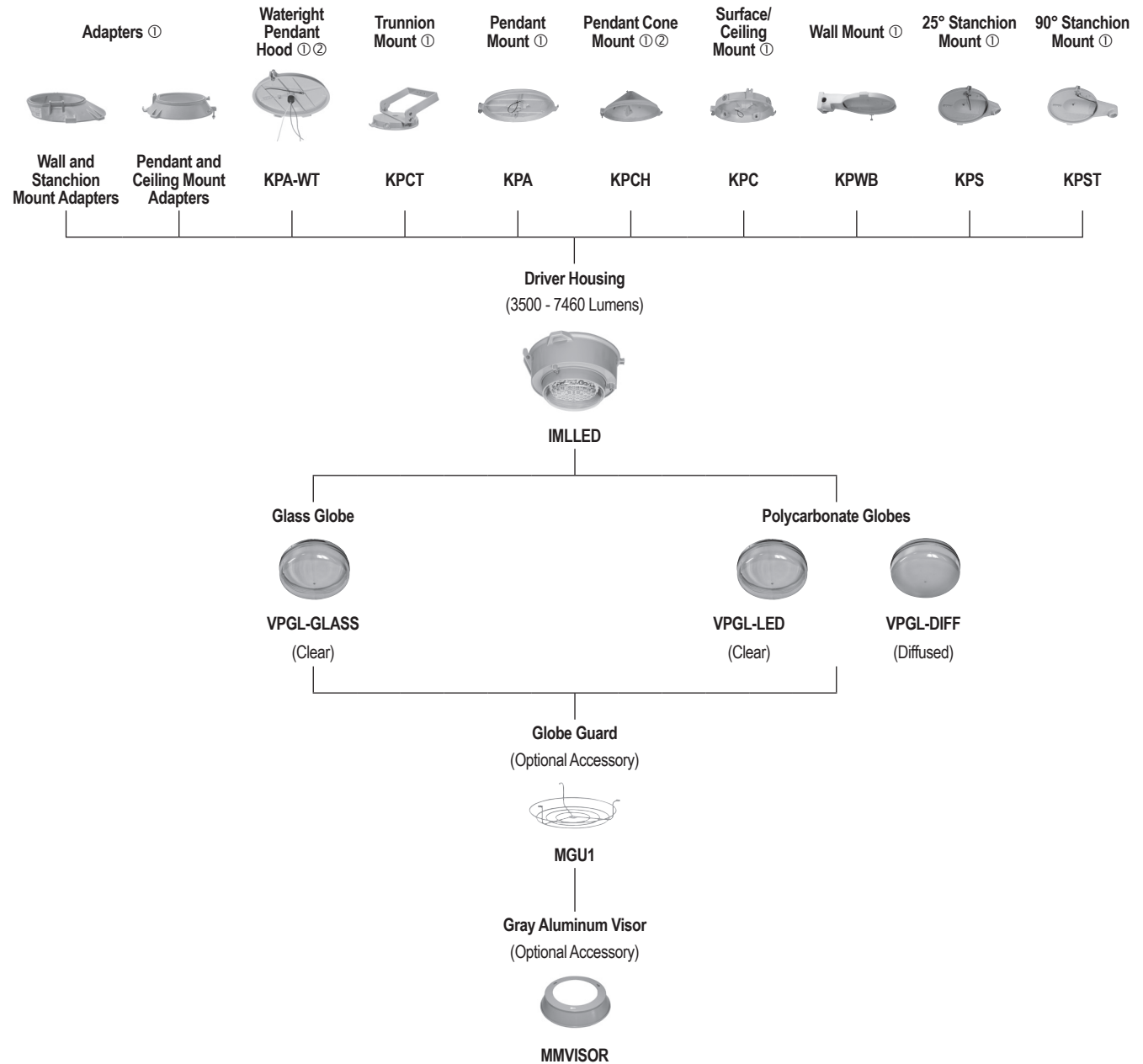

① See Mounting Hood Adapters table for part numbers.

② Certified for cCSAus only.

⌘ Use of fuse voids Marine Outside Type (Salt Water) rating.

Industrial Mercmaster™ LED Low Profile Series Luminaires

Standard

Ordinary Locations

NEC/CEC Standard Model: Type 3R, 4, 4X | IP66 | IP67 | Suitable for Use in Wet Locations | Marine Outside Type (Salt Water) ⌘

IECEE CB Standard Model: IK08

Notable: American Bureau of Shipping (ABS) Certified | International Dark Sky (IDA) Approved (Standard Model Only) | 10G Vibration

Order Using Catalog Numbering Guide — Industrial Mercmaster™ LED Low Profile Series Luminaires — Standard Model

IMLLED	A	4	2	C	P	5	BU	F	C	1
Series Prefix: IMLLED - Industrial Mercmaster LED Low Profile Series	Mounting:		Hub Size: ① ⑦ 2 - 3/4" NPT 3 - 1" NPT 4 - 1-1/4" NPT stanchion 5 - 1-1/2" NPT stanchion 6 - Metric M20 † Blank - No hub if using adapter or ordering driver housing only (no mounting hood)	Color Temperature: ‡ C - Cool, 5000K N - Neutral, 4000K W - Warm, 3000K S - HPS, 1800K CCT A - Yellow Amber		Light Distribution Pattern: 5 - Type V	Voltage: ⑧ ⑨ BU - 100-277 Vac, 50/60 Hz; 125-300 Vdc BH - 347-480 Vac, 50/60 Hz ▲ B2 - 24-48 Vdc		Operating Temperature: ⑩ C - Cold Temperature -50 °C (-58 °F) Min. Ambient Blank - Standard -40 °C (-40 °F) Min. Ambient	Options: 1 - Photocontrol 120V ⑤ 2 - Photocontrol 208- 277V ⑤ Blank - No Options Chosen
		Lumen (nominal): ② 2 - 3,300 3 - 4,400 4 - 5,500 7 - 7,500 ⑩		Globe Material: ③ P - Clear Polycarbonate Globe D - Diffused Polycarbonate Globe G - Clear Glass Globe J - Glass Prismatic Refractor			Fusing: ④ F - Fusing Blank - No fusing			

① 3/4" NPT, 1" NPT and Metric M20 hub entries are not offered in 90° and 25° Stanchion mounting options.

② For lumen output information, see Lumen Output (Efficacy) Table.

③ Guards for the refractor and globes are ordered separately. See the Accessories for more information.

④ Fusing only permitted for cCSAus rating. Factory installed. Use of fuse voids Marine Outside Type (Salt Water) rating. Fusing is mounted in the driver housing. For retrofit applications, fusing must be removed from the mounting hood and ordered in the luminaire.

⑤ Luminaires with photocontrol are not rated IP66/67, Marine Outside Type (Salt Water), or Class II and voids the NEMA ratings on the fixture but remains suitable for use in wet locations. Photocontrol available for 120-277 Vac only.

⑥ Ceiling and pendant cone hood mounted luminaires are not designed to use the PCD2 photocontrol. Ceiling mounts can be used with a FS/FD box with a photocontrol. Contact your local sales representative for more information.

⑦ Hub size does not apply to luminaires ordered with adapters.

⑧ Luminaires have 0-10V variable dimming input providing 10% to 100% dimming curve for BU/BH voltage options at standard temperature and 0% to 100% dimming curve for B2 voltage or cold temperature models.

⑨ Cold temperature option is available for use with BU (100-277 Vac), or B2 (24-48 Vdc) voltages only. Not available with Photocontrol.

⑩ Operating temperature range is -40 °C to +60 °C (-40 °F to +140 °F) for BU/BH standard; -50 °C to +60 °C (-58 °F to +140 °F) for BU/BH cold temperature; -40 °C to +65 °C (-40 °F to +149 °F) for B2 standard; -40 °C to +65 °C (-58 °F to +149 °F) for B2 cold temperature.

† Metric M20 hub size is only available with Ceiling, Trunnion and Wall mount options.

‡ Other CCT options available upon request. Contact your local sales representative for more information.

▲ Adapters, watertight pendant hood and BH Voltage only certified for cCSAus. Adapters and BH Voltage are not available for use with photocontrol.

↳ Killark is a registered trademark of Hubbell Incorporated.

↳ Crouse-Hinds is a registered trademark of Cooper Industries, Inc. a wholly owned subsidiary of the Eaton Corporation plc.

⌘ Use of fuse voids Marine Outside Type (Salt Water) rating.

Industrial Mercmaster™ LED Low Profile Series Luminaires

With Emergency Battery Backup
Ordinary Locations

NEC/CEC Emergency Battery Backup Model: Type 3R, 4, 4X | IP66 | IP67 | Suitable for Use in Wet Locations | Marine Outside Type (Salt Water) ⌘
Notable: American Bureau of Shipping (ABS) Certified | 10G Vibration

Order Using Catalog Numbering Guide — Mercmaster™ LED Low Profile Series Luminaires — Emergency Battery Backup Model

<p>IMLED</p> <p>Series Prefix: MLED - NEC/CEC Certified Industrial Mercmaster LED Low Profile Series with Emergency Battery Backup</p>	<p>A</p> <p>Mounting:</p> <p>A - Pendant B - Watertight Pendant ▲ C - Surface/Ceiling ✦ D - Pendant Cone ▲ R - 90° Stanchion ① S - 25° Stanchion ① T - Trunnion ✦ K - Killark™ ✦ Adapter Universal ▲ U - Mercmaster II Adapter, Ceiling or Pendant ▲④ V - Mercmaster II Adapter, Stanchion or Wall ▲④ W - Wall ✦ X - Crouse Hinds™ ✦ Adapter, Ceiling or Pendant ▲ Y - Crouse Hinds™ ✦ Adapter, Stanchion or Wall ▲ Blank - No mounting hood</p>	<p>4</p> <p>Lumen (nominal): ②</p> <p>2 - 3,300 3 - 4,400 4 - 5,500 7 - 7,500</p>	<p>2</p> <p>Hub Size: ① ④</p> <p>2 - 3/4" NPT 3 - 1" NPT 4 - 1-1/4" NPT stanchion 5 - 1-1/2" NPT stanchion 6 - Metric M20 ✦ Blank - No hub if using adapter or ordering driver housing only (no mounting hood)</p>	<p>C</p> <p>Color Temperature: ‡</p> <p>C - Cool, 5000K N - Neutral, 4000K W - Warm, 3000K S - HPS, 1800K CCT A - Yellow Amber</p>	<p>P</p> <p>Globe Material: ③</p> <p>P - Clear Polycarbonate Globe D - Diffused Polycarbonate Globe G - Clear Glass Globe</p>	<p>5</p> <p>Light Distribution Pattern: 5 - Type V</p>	<p>BU</p> <p>Voltage: ⑤</p> <p>BU - 120-277 Vac, 50/60 Hz</p>	<p>H</p> <p>Emergency: ⑥</p> <p>H - 90 Minutes E - 180 Minutes</p>
---	---	--	---	---	--	---	--	---

① 3/4" NPT, 1" NPT and Metric M20 hub entries are not offered in 90° and 25° Stanchion mounting options.

② For lumen output information, see Lumen Output (Efficacy) Table.

③ Guard for the globe must be ordered separately. See the Accessories for more information.

④ Hub size does not apply to luminaires ordered with adapters.

⑤ All luminaires ship standard with a two-wire, 0-10V variable dimming input port for controlling the light output from 10% to 100% of the rated lumen output. Luminaire cannot be dimmed in emergency mode.

✦ Metric M20 hub size is only available with Ceiling, Trunnion and Wall mount options.

‡ Other CCT options available upon request. Contact your local sales representative for more information.

▲ Adapters and watertight pendant hood only certified for cCSAus.

✦ Killark is a registered trademark of Hubbell Incorporated.

✦ Crouse-Hinds is a registered trademark of Cooper Industries, Inc. a wholly owned subsidiary of the Eaton Corporation plc.

⌘ Use of fuse voids Marine Outside Type (Salt Water) rating.

Industrial Mercmaster™ LED Low Profile Series Luminaires

Standard

Ordinary Locations

NEC/CEC Standard Model: Type 3R, 4, 4X | IP66 | IP67 | Suitable for Use in Wet Locations | Marine Outside Type (Salt Water) ⌘

IECEE CB Standard Model: IK08

Notable: American Bureau of Shipping (ABS) Certified | International Dark Sky (IDA) Approved (Standard Model Only) | 10G Vibration

Lumen Output (Efficacy) — Standard Model ①

Model	HID Equivalency	Light Distribution Pattern	CCT (Correlated Color Temperature)	CRI (Color Rendering Index)	Lumen Output	Efficacy (lm/W)	CCT	CRI	Lumen Output	Efficacy (lm/W)	CCT	CRI	Lumen Output	Efficacy (lm/W)
Clear Polycarbonate Globe														
IMLLED2	70-100W	Type V	3000K	80	2900	104	4000K	80	3000	107	5000K	70	3400	121
IMLLED3	100-150W	Type V	3000K	80	3850	101	4000K	80	4000	105	5000K	70	4550	120
IMLLED4	150-175W	Type V	3000K	80	4850	101	4000K	80	5000	104	5000K	70	5700	119
IMLLED7	175-250W	Type V	3000K	80	5480	107	4000K	80	5670	111	5000K	70	7080	139
IMLLED2	70-100W	Type V	1800K	70	2570	76	Amber	N/A	2240	66				
IMLLED3	100-150W	Type V	1800K	70	2955	74	Amber	N/A	2570	64				
IMLLED4	150-175W	Type V	1800K	70	3540	75	Amber	N/A	3060	64				
IMLLED7	175-250W	Type V	1800K	70	4400	88	Amber	N/A	3850	77				
Diffused Polycarbonate Globe														
IMLLED2	70-100W	Type V	3000K	80	2850	102	4000K	80	3000	107	5000K	70	3400	121
IMLLED3	100-150W	Type V	3000K	80	3800	100	4000K	80	4000	105	5000K	70	4500	118
IMLLED4	150-175W	Type V	3000K	80	4700	98	4000K	80	5000	104	5000K	70	5700	119
IMLLED7	175-250W	Type V	3000K	80	5390	106	4000K	80	5580	109	5000K	70	6960	136
IMLLED2	70-100W	Type V	1800K	70	2540	75	Amber	N/A	2220	65				
IMLLED3	100-150W	Type V	1800K	70	2920	73	Amber	N/A	2530	63				
IMLLED4	150-175W	Type V	1800K	70	3490	73	Amber	N/A	3020	64				
IMLLED7	175-250W	Type V	1800K	70	4300	86	Amber	N/A	3780	76				
Clear Glass Globe														
IMLLED2	70-100W	Type V	3000K	80	3000	107	4000K	80	3100	111	5000K	70	3500	125
IMLLED3	100-150W	Type V	3000K	80	3975	105	4000K	80	4175	110	5000K	70	4750	125
IMLLED4	150-175W	Type V	3000K	80	5000	104	4000K	80	5300	110	5000K	70	6000	125
IMLLED7	175-250W	Type V	3000K	80	5720	112	4000K	80	5920	116	5000K	70	7460	146
IMLLED2	70-100W	Type V	1800K	70	2685	79	Amber	N/A	2350	69				
IMLLED3	100-150W	Type V	1800K	70	3090	77	Amber	N/A	2690	67				
IMLLED4	150-175W	Type V	1800K	70	3600	75	Amber	N/A	3200	67				
IMLLED7	175-250W	Type V	1800K	70	4600	92	Amber	N/A	4050	81				
Glass Prismatic Refractor														
IMLLED2	70-100W	Type V	3000K	80	2835	101	4000K	80	3000	107	5000K	70	3450	123
IMLLED3	100-150W	Type V	3000K	80	3700	97	4000K	80	4050	107	5000K	70	4600	121
IMLLED4	150-175W	Type V	3000K	80	4500	94	4000K	80	5100	106	5000K	70	5800	121
IMLLED7	175-250W	Type V	3000K	80	5370	105	4000K	80	5550	109	5000K	70	6850	134
IMLLED2	70-100W	Type V	1800K	70	2570	76	Amber	N/A	2250	66				
IMLLED3	100-150W	Type V	1800K	70	2565	64	Amber	N/A	2590	65				
IMLLED4	150-175W	Type V	1800K	70	3545	75	Amber	N/A	3080	65				
IMLLED7	175-250W	Type V	1800K	70	4200	84	Amber	N/A	3700	74				

① All lumen values are typical (tolerance +/- 10%).

⌘ Use of fuse voids Marine Outside Type (Salt Water) rating.

Industrial Mercmaster™ LED Low Profile Series Luminaires

With Emergency Battery Backup
Ordinary Locations

NEC/CEC Emergency Battery Backup Model: Type 3R, 4, 4X | IP66 | IP67 | Suitable for Use in Wet Locations | Marine Outside Type (Salt Water) ⌘
Notable: American Bureau of Shipping (ABS) Certified | 10G Vibration

Lumen Output (Efficacy) — Emergency Battery Backup Model ①②

Model	HID Equivalency	Light Distribution Pattern	CCT (Correlated Color Temperature)	CRI (Color Rendering Index)	Lumen Output	Efficacy (lm/W)	CCT	CRI	Lumen Output	Efficacy (lm/W)	CCT	CRI	Lumen Output	Efficacy (lm/W)
Clear Polycarbonate Globe — Standard Mode														
IMLLED2	70-100W	Type V	3000K	70	3000	91	4000K	70	3200	97	5000K	70	3200	97
IMLLED3	100-150W	Type V	3000K	70	3900	98	4000K	70	4200	105	5000K	70	4200	105
IMLLED4	150-175W	Type V	3000K	70	4900	100	4000K	70	5000	102	5000K	70	5300	108
IMLLED7	175-250W	Type V	3000K	70	5480	98	4000K	70	5670	101	5000K	70	7080	126
IMLLED2	70-100W	Type V	1800K	70	2570	71	Amber	N/A	2240	62				
IMLLED3	100-150W	Type V	1800K	70	2955	66	Amber	N/A	2570	57				
IMLLED4	150-175W	Type V	1800K	70	3540	67	Amber	N/A	3060	58				
IMLLED7	175-250W	Type V	1800K	70	3720	66	Amber	N/A	3850	69				
Clear Polycarbonate Globe — 90 Minute Emergency Mode														
IMLLED2	70-100W	Type V	3000K	70	1150	N/A	4000K	70	1270	N/A	5000K	70	1400	N/A
IMLLED3	100-150W	Type V	3000K	70	1150	N/A	4000K	70	1270	N/A	5000K	70	1400	N/A
IMLLED4	150-175W	Type V	3000K	70	1150	N/A	4000K	70	1270	N/A	5000K	70	1400	N/A
IMLLED7	175-250W	Type V	3000K	70	1425	N/A	4000K	70	1475	N/A	5000K	70	1625	N/A
IMLLED2	70-100W	Type V	1800K	70	930	N/A	Amber	N/A	830	N/A				
IMLLED3	100-150W	Type V	1800K	70	930	N/A	Amber	N/A	830	N/A				
IMLLED4	150-175W	Type V	1800K	70	930	N/A	Amber	N/A	830	N/A				
IMLLED7	175-250W	Type V	1800K	70	930	N/A	Amber	N/A	830	N/A				
Clear Polycarbonate Globe — 180 Minute Emergency Mode														
IMLLED2	70-100W	Type V	3000K	70	625	N/A	4000K	70	700	N/A	5000K	70	775	N/A
IMLLED3	100-150W	Type V	3000K	70	625	N/A	4000K	70	700	N/A	5000K	70	775	N/A
IMLLED4	150-175W	Type V	3000K	70	625	N/A	4000K	70	700	N/A	5000K	70	775	N/A
IMLLED7	175-250W	Type V	3000K	70	825	N/A	4000K	70	875	N/A	5000K	70	950	N/A
IMLLED2	70-100W	Type V	1800K	70	550	N/A	Amber	N/A	490	N/A				
IMLLED3	100-150W	Type V	1800K	70	550	N/A	Amber	N/A	490	N/A				
IMLLED4	150-175W	Type V	1800K	70	550	N/A	Amber	N/A	490	N/A				
IMLLED7	175-250W	Type V	1800K	70	550	N/A	Amber	N/A	490	N/A				
Diffused Polycarbonate Globe — Standard Mode														
IMLLED2	70-100W	Type V	3000K	70	2900	88	4000K	70	3100	94	5000K	70	3100	94
IMLLED3	100-150W	Type V	3000K	70	3800	95	4000K	70	3900	98	5000K	70	4100	103
IMLLED4	150-175W	Type V	3000K	70	4800	98	4000K	70	4900	100	5000K	70	5150	105
IMLLED7	175-250W	Type V	3000K	70	5390	96	4000K	70	5580	100	5000K	70	6960	124
IMLLED2	70-100W	Type V	1800K	70	2540	71	Amber	N/A	2220	62				
IMLLED3	100-150W	Type V	1800K	70	2920	65	Amber	N/A	2530	56				
IMLLED4	150-175W	Type V	1800K	70	3490	66	Amber	N/A	3020	57				
IMLLED7	175-250W	Type V	1800K	70	3690	66	Amber	N/A	3780	68				
Diffused Polycarbonate Globe — 90 Minute Emergency Mode														
IMLLED2	70-100W	Type V	3000K	70	1100	N/A	4000K	70	1200	N/A	5000K	70	1350	N/A
IMLLED3	100-150W	Type V	3000K	70	1100	N/A	4000K	70	1200	N/A	5000K	70	1350	N/A
IMLLED4	150-175W	Type V	3000K	70	1100	N/A	4000K	70	1200	N/A	5000K	70	1350	N/A
IMLLED7	175-250W	Type V	3000K	70	1400	N/A	4000K	70	1450	N/A	5000K	70	1600	N/A
IMLLED2	70-100W	Type V	1800K	70	900	N/A	Amber	N/A	800	N/A				
IMLLED3	100-150W	Type V	1800K	70	900	N/A	Amber	N/A	800	N/A				
IMLLED4	150-175W	Type V	1800K	70	900	N/A	Amber	N/A	800	N/A				
IMLLED7	175-250W	Type V	1800K	70	900	N/A	Amber	N/A	800	N/A				

① All lumen values are typical (tolerance +/-10%). For Lumen Output (Efficacy) of the emergency battery backup model in 180 minute emergency mode, contact your local sales representative.

② 70 minimum.

⌘ Use of fuse voids Marine Outside Type (Salt Water) rating.

Industrial Mercmaster™ LED Low Profile Series Luminaires

With Emergency Battery Backup
Ordinary Locations

NEC/CEC Emergency Battery Backup Model: Type 3R, 4, 4X | IP66 | IP67 | Suitable for Use in Wet Locations | Marine Outside Type (Salt Water) ⌘
 Notable: American Bureau of Shipping (ABS) Certified | 10G Vibration

Lumen Output (Efficacy) — Emergency Battery Backup Model ① ②

Model	HID Equivalency	Light Distribution Pattern	CCT (Correlated Color Temperature)	CRI (Color Rendering Index)	Lumen Output	Efficacy (lm/W)	CCT	CRI	Lumen Output	Efficacy (lm/W)	CCT	CRI	Lumen Output	Efficacy (lm/W)
Diffused Polycarbonate Globe — 180 Minute Emergency Mode														
IMLLED2	70-100W	Type V	3000K	80	600	N/A	4000K	80	675	N/A	5000K	70	750	N/A
IMLLED3	100-150W	Type V	3000K	80	600	N/A	4000K	80	675	N/A	5000K	70	750	N/A
IMLLED4	150-175W	Type V	3000K	80	600	N/A	4000K	80	675	N/A	5000K	70	750	N/A
IMLLED7	175-250W	Type V	3000K	80	800	N/A	4000K	80	850	N/A	5000K	70	925	N/A
IMLLED2	70-100W	Type V	1800K	70	540	N/A	Amber	N/A	470	N/A				
IMLLED3	100-150W	Type V	1800K	70	540	N/A	Amber	N/A	470	N/A				
IMLLED4	150-175W	Type V	1800K	70	540	N/A	Amber	N/A	470	N/A				
IMLLED7	175-250W	Type V	1800K	70	540	N/A	Amber	N/A	470	N/A				
Clear Glass Globe — Standard Mode														
IMLLED2	70-100W	Type V	3000K	80	3100	94	4000K	80	3100	94	5000K	70	3300	100
IMLLED3	100-150W	Type V	3000K	80	4100	103	4000K	80	4200	105	5000K	70	4400	110
IMLLED4	150-175W	Type V	3000K	80	5000	102	4000K	80	5200	106	5000K	70	5500	112
IMLLED7	175-250W	Type V	3000K	80	5720	102	4000K	80	5920	106	5000K	70	7460	133
IMLLED2	70-100W	Type V	1800K	70	2685	75	Amber	N/A	2350	65				
IMLLED3	100-150W	Type V	1800K	70	3090	69	Amber	N/A	2690	60				
IMLLED4	150-175W	Type V	1800K	70	3600	68	Amber	N/A	3200	60				
IMLLED7	175-250W	Type V	1800K	70	3850	69	Amber	N/A	4050	72				
Clear Glass Globe — 90 Minute Emergency Mode														
IMLLED2	70-100W	Type V	3000K	80	1200	N/A	4000K	80	1330	N/A	5000K	70	1450	N/A
IMLLED3	100-150W	Type V	3000K	80	1200	N/A	4000K	80	1330	N/A	5000K	70	1450	N/A
IMLLED4	150-175W	Type V	3000K	80	1200	N/A	4000K	80	1330	N/A	5000K	70	1450	N/A
IMLLED7	175-250W	Type V	3000K	80	1500	N/A	4000K	80	1550	N/A	5000K	70	1700	N/A
IMLLED2	70-100W	Type V	1800K	70	960	N/A	Amber	N/A	860	N/A				
IMLLED3	100-150W	Type V	1800K	70	960	N/A	Amber	N/A	860	N/A				
IMLLED4	150-175W	Type V	1800K	70	960	N/A	Amber	N/A	860	N/A				
IMLLED7	175-250W	Type V	1800K	70	960	N/A	Amber	N/A	860	N/A				
Clear Glass Globe — 180 Minute Emergency Mode														
IMLLED2	70-100W	Type V	3000K	80	675	N/A	4000K	80	725	N/A	5000K	70	800	N/A
IMLLED3	100-150W	Type V	3000K	80	675	N/A	4000K	80	725	N/A	5000K	70	800	N/A
IMLLED4	150-175W	Type V	3000K	80	675	N/A	4000K	80	725	N/A	5000K	70	800	N/A
IMLLED7	175-250W	Type V	3000K	80	850	N/A	4000K	80	900	N/A	5000K	70	1000	N/A
IMLLED2	70-100W	Type V	1800K	70	570	N/A	Amber	N/A	510	N/A				
IMLLED3	100-150W	Type V	1800K	70	570	N/A	Amber	N/A	510	N/A				
IMLLED4	150-175W	Type V	1800K	70	570	N/A	Amber	N/A	510	N/A				
IMLLED7	175-250W	Type V	1800K	70	570	N/A	Amber	N/A	510	N/A				

① All lumen values are typical (tolerance +/-10%). For Lumen Output (Efficacy) of the emergency battery backup model in 180 minute emergency mode, contact your local sales representative.

② 70 minimum.

⌘ Use of fuse voids Marine Outside Type (Salt Water) rating.

Industrial Mercmaster™ LED Low Profile Series Luminaires

Standard

Ordinary Locations

NEC/CEC Standard Model: Type 3R, 4, 4X | IP66 | IP67 | Suitable for Use in Wet Locations | Marine Outside Type (Salt Water) ⌘

IECEE CB Standard Model: IK08

Notable: American Bureau of Shipping (ABS) Certified | International Dark Sky (IDA) Approved (Standard Model Only) | 10G Vibration

Electrical Specifications — Standard Model ①

Model	Operating Temperature	Voltage	Max. Input Power (Watts)	Max. Input Current (Amps)	Power Factor (PF)	Total Harmonic Distortion (THD)
IMLLED2	-40 °C to +65 °C (-40 °F to +149 °F)	100 Vac	32	0.32	>0.9	< 20%
		277 Vac	32	0.12		
		125 Vdc	32	0.28	N/A	N/A
		300 Vdc	32	0.11		
		347 Vac	32	0.10	>0.9	< 20%
		480 Vac	32	0.08		
		24 Vdc	30	1.20	N/A	N/A
		48 Vdc	30	0.60		
		120 Vac	32	0.32	>0.9	< 20%
		277 Vac	32	0.12		
24 Vdc	30	1.20	N/A	N/A		
48 Vdc	30	0.60				
IMLLED3	-40 °C to +65 °C (-40 °F to +149 °F)	100 Vac	40	0.40	>0.9	< 20%
		277 Vac	40	0.15		
		125 Vdc	40	0.32	N/A	N/A
		300 Vdc	40	0.13		
		347 Vac	40	0.12	>0.9	< 20%
		480 Vac	40	0.09		
		24 Vdc	35	1.44	N/A	N/A
		48 Vdc	35	0.71		
		120 Vac	40	0.40	>0.9	< 20%
		277 Vac	40	0.15		
24 Vdc	35	1.44	N/A	N/A		
48 Vdc	35	0.71				
IMLLED4	-40 °C to +65 °C (-40 °F to +149 °F)	100 Vac	49	0.49	>0.9	< 20%
		277 Vac	49	0.18		
		125 Vdc	49	0.39	N/A	N/A
		300 Vdc	49	0.15		
		347 Vac	49	0.14	>0.9	< 20%
		480 Vac	49	0.10		
		24 Vdc	43	1.78	N/A	N/A
		48 Vdc	43	0.87		
		120 Vac	49	0.49	>0.9	< 20%
		277 Vac	49	0.18		
24 Vdc	43	1.78	N/A	N/A		
48 Vdc	43	0.87				
IMLLED7	-40 °C to +60 °C (-40 °F to +140 °F)	100 Vac	53	0.52	>0.9	< 20%
		277 Vac	53	0.19		
		125 Vdc	53	0.41	N/A	N/A
		300 Vdc	53	0.17		
		347 Vac	53	0.15	>0.9	< 20%
		480 Vac	53	0.11		
		24 Vdc	46	1.87	N/A	N/A
		48 Vdc	46	0.92		
		120 Vac	53	0.52	>0.9	< 20%
		277 Vac	53	0.19		
24 Vdc	46	1.87	N/A	N/A		
48 Vdc	46	0.92				

① All values are typical (tolerance +/-10%).

⌘ Use of fuse voids Marine Outside Type (Salt Water) rating.

Industrial Mercmaster™ LED Low Profile Series Luminaires

With Emergency Battery Backup
Ordinary Locations

NEC/CEC Emergency Battery Backup Model: Type 3R, 4, 4X | IP66 | IP67 | Suitable for Use in Wet Locations | Marine Outside Type (Salt Water) ⌘
Notable: American Bureau of Shipping (ABS) Certified | 10G Vibration

Electrical Specifications — Emergency Model ①

Model	Voltage	Max. Input Power (Watts)	Max. Input Current (Amps)	Power Factor (PF)	Total Harmonic Distortion (THD)
IMLLED2	120 Vac	39	0.33	> 0.9	< 20%
	277 Vac	39	0.16		
IMLLED3	120 Vac	45	0.38	> 0.9	
	277 Vac	45	0.18		
IMLLED4	120 Vac	53	0.45	> 0.9	
	277 Vac	53	0.21		
IMLLED7	120 Vac	56	0.47	> 0.9	
	277 Vac	56	0.22		

Automatic Testing System (ATS) — Emergency Battery Backup Model — Functionality

Functional	Full Duration
Starts within 24 to 45 hours after the initial powerup of the module	Starts within 5 to 26 days after the initial power of the module
Occurs every 14 days after the initial aforementioned functional test	Occurs every 364 days after the initial aforementioned functional test
Lasts for 30 seconds	Lasts for the full duration of the rated emergency period
At the completion of functional and full duration tests, LED indicator will display the status of the emergency luminaire when AC is present	

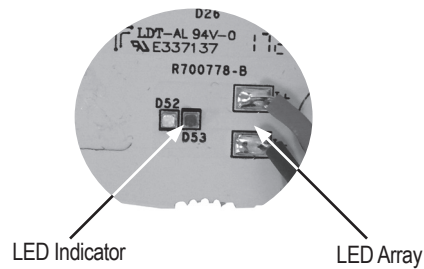

LED Signals

Indicator Color	Timing	Description
Green	1 sec ON: 1 sec OFF	Normal charging ok, Battery not yet fully charged, No fault detected, Testing ok
Green	0.25 sec ON: 0.25 sec OFF	Functional / Duration Self-Test on-going
Green	Steady ON	Charging ok, Battery fully charged, No fault detected, Testing ok
Red	1 sec ON: 1 sec OFF	Fault condition. Installation issue. Battery is reverse, not connected or shorted. Functional test failure, full duration test failure
LED Indicators OFF, LED Array ON	LED Indicator Lights (Red and Green) OFF	No AC, Emergency mode ON

① All values are typical (tolerance +/-10%).





⌘ Use of fuse voids Marine Outside Type (Salt Water) rating.

Industrial Mercmaster™ LED Low Profile Series Luminaires

Standard or with Emergency Battery Backup
Ordinary Locations

NEC/CEC Standard Model: Type 3R, 4, 4X | IP66 | IP67 | Suitable for Use in Wet Locations | Marine Outside Type (Salt Water) ⌘
NEC/CEC Emergency Battery Backup Model: Type 3R, 4, 4X | IP66 | IP67 | Suitable for Use in Wet Locations | Marine Outside Type (Salt Water) ⌘
IECEE CB Standard Model: IK08
Notable: American Bureau of Shipping (ABS) Certified | International Dark Sky (IDA) Approved (Standard Model Only) | 10G Vibration

Effective Projected Area Calculations for Outdoor Luminaires

Luminaire		Effective Projected Area (EPA) = FPA*DC ft ²
Pendant Mount		0.67
Ceiling Mount		0.91
Wall Mount		0.68
25° Stanchion Mount		0.74
90° Stanchion Mount		0.73









Industrial Mercmaster™ LED Low Profile Series Luminaires

Standard or with Emergency Battery Backup



Ordinary Locations

NEC/CEC Standard Model: Type 3R, 4, 4X | IP66 | IP67 | Suitable for Use in Wet Locations | Marine Outside Type (Salt Water) ⌘
 NEC/CEC Emergency Battery Backup Model: Type 3R, 4, 4X | IP66 | IP67 | Suitable for Use in Wet Locations | Marine Outside Type (Salt Water) ⌘
 IECCE CB Standard Model: IK08
 Notable: American Bureau of Shipping (ABS) Certified | International Dark Sky (IDA) Approved (Standard Model Only) | 10G Vibration

Mounting Hoods — All Models

Hub Size	Weight in kg (lbs)	Catalog Number	Hub Size	Weight in kg (lbs)	Catalog Number
Pendant — One Hub, Rigid Mounting			Surface/Ceiling — Five Hubs, Four Close-Up Plugs		
 3/4" NPT		KPA-75	 3/4		KPC-75
1" NPT	1.0 (2.3)	KPA-100	1	1.4 (3.0)	KPC-100
M20		KPA-M20	M20		KPC-M20
Pendant Cone — One Hub, Rigid Mounting			Wall — Five Hubs, Four Close-Up Plugs		
 3/4" NPT		KPCH-75	 3/4		KPWB-75
1" NPT	1.1 (2.5)	KPCH-100	1	1.8 (4.0)	KPWB-100
M20		KPCH-M20	M20		KPWB-M20
Watertight Pendant Hood — One Hub, Rigid Mounting			25° Stanchion — One Hub		
 3/4" NPT		KPA-75-WT	 1-1/4" NPT		KPS-125
1" NPT	1.1 (2.4)	KPA-100-WT	1-1/2" NPT	1.5 (3.3)	KPS-150
M20		KPA-WT-M20			
Trunnion — Five Hubs, Four Close-Up Plugs			90° Stanchion — One Hub		
 3/4" NPT		KPCT-75	 1-1/4" NPT		KPST-125
1" NPT	5.3 (11.7)	KPCT-100	1-1/2" NPT	1.7 (3.8)	KPST-150
M20		KPCT-M20			

Mounting Hood Adapters — All Models ①

Manufacturer	Installed Mounting Hood	Weight in kg (lbs)	Appleton Adapter Catalog Number
 Crouse-Hinds™ Champ® †	Pendant: APM2/3 Ceiling: CM2/3 Flexible Pendant: HPM2	0.9 (2.00)	MMADCHVS
Appleton™ Mercmaster™ II	Pendant: LPA75/100 Ceiling: LPC75/100	0.9 (2.00)	MMADIIS
 Crouse-Hinds™ Champ® †	Wall: TWM2/3 25° Angle Stanchion: JM5 90° Angle Stanchion: PM5	0.9 (2.00)	MMADCHVA
Appleton™ Mercmaster™ II	Wall: LPWB75, LPWB100 25° Angle Stanchion: LPS125, LPS150	0.9 (2.00)	MMADIIA
 Killark™ ‡	Ceiling: VMX2B, VMX3B, VMX6B, VMX7B, VMX9B Pendant: VMA2B, VMA3B Stanchion: VMD4B, VMD5B, VMS4B, VMS5B Wall: VMB2B, VMB3B Pendant Cone: VMC2B, VMC3B	1.0 (2.3)	MMADKVA

① Adapters are cCSAus rated only.

‡ Killark is a registered trademark of Hubbell Incorporated.

† Crouse-Hinds and Champ are registered trademarks of Cooper Industries, Inc., a wholly owned subsidiary of the Eaton Corporation plc.

⌘ Use of fuse voids Marine Outside Type (Salt Water) rating.





Industrial Mercmaster™ LED Low Profile Series Luminaires

Standard or with Emergency Battery Backup

Ordinary Locations

NEC/CEC Standard Model: Type 3R, 4, 4X | IP66 | IP67 | Suitable for Use in Wet Locations | Marine Outside Type (Salt Water) ⚠
 NEC/CEC Emergency Battery Backup Model: Type 3R, 4, 4X | IP66 | IP67 | Suitable for Use in Wet Locations | Marine Outside Type (Salt Water) ⚠
 IECCE CB Standard Model: IK08
 Notable: American Bureau of Shipping (ABS) Certified | International Dark Sky (IDA) Approved (Standard Model Only) | 10G Vibration

Accessories and Replacement Parts — All Models

	Description	Weight in kg (lbs)	Catalog Number
Globes			
	Clear Globe — Polycarbonate	0.2 (0.5)	VPGL-LED
	Diffused Globe — Polycarbonate	0.2 (0.5)	VPGL-DIFF
	Clear Globe — Glass	0.8 (1.7)	VPGL-GLASS
Guard			
	Globe Guard — Stainless Steel	0.2 (0.4)	MGU1
Safety Cable			
	Safety Cable — Stainless Steel	0.2 (0.4)	LEDSC
Visor			
	Electrostatically applied gray epoxy powder coat finish on Aluminum Visor	0.4 (0.9)	MMVISOR

⚠ Use of fuse voids Marine Outside Type (Salt Water) rating.

Industrial Mercmaster™ LED Low Profile Series Luminaires

Standard







Ordinary Locations

NEC/CEC Standard Model: Type 3R, 4, 4X | IP66 | IP67 | Suitable for Use in Wet Locations | Marine Outside Type (Salt Water) ⌘

IECEE CB Standard Model

Notable: American Bureau of Shipping (ABS) Certified | International Dark Sky (IDA) Approved (Standard Model Only) | 10G Vibration

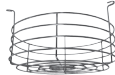
Accessories and Replacement Parts — Standard Model

Description	Weight in kg (lbs)	Catalog Number				
Globes ①						
 Glass Globe — Amber	0.2 (0.5)	VPGLGLASSAM				
 Glass Globe — Blue	0.2 (0.5)	VPGLGLASSBL				
 Glass Globe — Red	0.8 (1.7)	VPGLGLASSRE				
 Glass Globe — Green	0.8 (1.7)	VPGLGLASSGR				
Light Distribution	Weight in kg (lbs)	Catalog Number				
Prismatic Glass Refractor — All Heat-Resistant ②						
 Short Prismatic Glass Refractor — NEMA Type V	1.4 (3.0)	LPG-R5S				
Description		Catalog Number				
Guards						
 Short Refractor Guard for LPG-R5S	0.3 (0.7)	KRG2S				
Model	Ambient Temperature	Voltage	Driver Wattage	CCT (Correlated Color Temperature)	Constant Current Settings	Catalog Number
Replacement Drivers						
	-40 °C to +65 °C (-40 °F to +149 °F)	BU				APMS050C135UD72
		BH	50 Watt	3000K, 4000K, 5000K	720mA	APMS050C135HD72
		B2				APMZ050C130DC72
		BU				APMS050C135UD55
	-50 °C to +65 °C (-58 °F to +149 °F)	BH	50 Watt	1800K, Amber	550mA	APMS050C135HD55
		B2				APMZ050C130DC55
		BU	50 Watt	3000K, 4000K, 5000K	720mA	APMZ050L135UD72
		B2				APMZ050C130DC72
	BU	50 Watt	1800K, Amber	550mA	APMZ050L135UD55	
	B2				APMZ050C130DC55	

① Certified for cCSAus only, with a T4 T-Code.

② Glass Prismatic Refractors are cCSAus rated only.

⌘ Use of fuse voids Marine Outside Type (Salt Water) rating.

Industrial Mercmaster™ LED Low Profile Series Luminaires

Standard

Ordinary Locations

NEC/CEC Standard Model: Type 3R, 4, 4X | IP66 | IP67 | Suitable for Use in Wet Locations | Marine Outside Type (Salt Water) ⌘

IECEE CB Standard Model

Notable: American Bureau of Shipping (ABS) Certified | International Dark Sky (IDA) Approved (Standard Model Only) | 10G Vibration

Accessories and Replacement Parts — Standard Model

Model	Ambient Temperature	Voltage	Driver Wattage	CCT (Correlated Color Temperature)	Constant Current Settings	Catalog Number		
Replacement Drivers								
IMLLED3	-40 °C to +65 °C (-40 °F to +149 °F)	BU				APMS050C135UD10		
		BH	50 Watt	3000K, 4000K, 5000K	1000mA	APMS050C135HD10		
		B2				APMZ050C130DC10		
		BU				APMS050C135UD64		
		BH	50 Watt	1800K, Amber	640mA	APMS050C135HD64		
		B2				APMZ050C130DC64		
	-50 °C to +65 °C (-58 °F to +149 °F)	BU					APMZ050L135UD10	
		B2	50 Watt	3000K, 4000K, 5000K	1000mA		APMZ050C130DC10	
		BU					APMZ050L135UD64	
		B2	50 Watt	1800K, Amber	640mA		APMZ050C130DC64	
		IMLLED4	-40 °C to +65 °C (-40 °F to +149 °F)	BU				APMS050C135UD13
				BH	50 Watt	3000K, 4000K, 5000K	1300mA	APMS050C135HD13
B2						APMZ050C130DC13		
BU						APMS050C135UD78		
BH	50 Watt			1800K, Amber	780mA	APMS050C135HD78		
B2						APMZ050C130DC78		
-50 °C to +65 °C (-58 °F to +149 °F)	BU						APMZ050L135UD13	
	B2		50 Watt	3000K, 4000K, 5000K	1300mA		APMZ050C130DC13	
	BU						APMZ050L135UD78	
	B2		50 Watt	1800K, Amber	780mA		APMZ050C130DC78	
	IMLLED7		-40 °C to +60 °C (-40 °F to +140 °F)	BU	50 Watt	ALL	825mA	APMS050C135UD82
				BH				APMS050C135HD82
-40 °C to +65 °C (-40 °F to +149 °F)		B2	50 Watt	ALL	825mA	APMZ050C130DC82		
		-50 °C to +60 °C (-58 °F to +140 °F)	BU	50 Watt	ALL	825mA	APMZ050L135UD82	
B2			50 Watt	ALL	825mA	APMZ050C130DC82		





Industrial Mercmaster™ LED Low Profile Series Luminaires

Standard or with Emergency Battery Backup

Ordinary Locations

NEC/CEC Standard Model: Type 3R, 4, 4X | IP66 | IP67 | Suitable for Use in Wet Locations | Marine Outside Type (Salt Water) ⌘
 NEC/CEC Emergency Battery Backup Model: Type 3R, 4, 4X | IP66 | IP67 | Suitable for Use in Wet Locations | Marine Outside Type (Salt Water) ⌘
 IEC EE CB Standard Model: IK08
 Notable: American Bureau of Shipping (ABS) Certified | International Dark Sky (IDA) Approved (Standard Model Only) | 10G Vibration

Accessories and Replacement Parts — Emergency Battery Backup Model

Description	Weight in kg (lbs)	Catalog Number
 Replacement Battery Pack	0.7 (1.5)	BPMLLED
 Replacement Battery Management Module	0.7 (1.5)	BMMLLED
Replacement Fuse (Emergency system)	0.2 (0.4)	MLF5

Model	Voltage	Driver Wattage	CCT (Correlated Color Temperature)	Constant Current Settings	Catalog Number	
Replacement Drivers and Battery Management Module with Battery						
	IMLLED2	BU	50 Watt	3000K, 4000K, 5000K	480mA	APMS050C135UD48
				1800K, Amber	550mA	APMS050C135UD55
	IMLLED3			3000K, 4000K, 5000K	610mA	APMS050C135UD61
				1800K, Amber	640mA	APMS050C135UD64
	IMLLED4			3000K, 4000K, 5000K	750mA	APMS050C135UD75
				1800K, Amber	780mA	APMS050C135UD78
	IMLLED7			All	825mA	APMS050C135UD82

Mounting Hood with Factory Installed Photocontrol — All Models ①

Mounting Hood	Hub Size	Photocontrol Option	Catalog Number
Pendant	3/4" NPT	120 V	KPA75PC12
		208 V, 240 V, 277 V	KPA75PC24
	1" NPT	120 V	KPA100PC12
		208 V, 240 V, 277 V	KPA100PC24
Watertight Pendant	3/4" NPT	120 V	KPA75WTPC12
		208 V, 240 V, 277 V	KPA75WTPC24
	1" NPT	120 V	KPA100WTPC12
		208 V, 240 V, 277 V	KPA100WTPC24
Wall	3/4" NPT	120 V	KPWB75PC12
		208 V, 240 V, 277 V	KPWB75PC24
	1" NPT	120 V	KPWB100PC12
		208 V, 240 V, 277 V	KPWB100PC24
25° Stanchion	1-1/4" NPT stanchion	120 V	KPS125PC12
		208 V, 240 V, 277 V	KPS125PC24
	1-1/2" NPT stanchion	120 V	KPS150PC12
		208 V, 240 V, 277 V	KPS150PC24
90° Stanchion	1-1/4" NPT stanchion	120 V	KPST125PC12
		208 V, 240 V, 277 V	KPST125PC24
	1-1/2" NPT stanchion	120 V	KPST150PC12
		208 V, 240 V, 277 V	KPST150PC24

① Fixtures with photocontrols are cCSAus rated, available for 120-277 Vac only, and are suitable for wet locations. The following ratings do not apply: IP, Marine Outside Type (Salt Water), NEMA.

⌘ Use of fuse voids Marine Outside Type (Salt Water) rating.

Industrial Mercmaster™ LED Low Profile Series Luminaires

Standard or with Emergency Battery Backup
Ordinary Locations

NEC/CEC Standard Model: Type 3R, 4, 4X | IP66 | IP67 | Suitable for Use in Wet Locations | Marine Outside Type (Salt Water) ⌘
NEC/CEC Emergency Battery Backup Model: Type 3R, 4, 4X | IP66 | IP67 | Suitable for Use in Wet Locations | Marine Outside Type (Salt Water) ⌘
IECEE CB Standard Model: IK08
Notable: American Bureau of Shipping (ABS) Certified | International Dark Sky (IDA) Approved (Standard Model Only) | 10G Vibration

Dimensions in Millimeters (Inches) — All Models with Polycarbonate Globe — Standard Model with Short Prismatic Glass Refractor

Pendant Mount — Globe

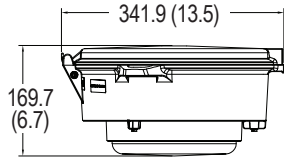

Pendant Mount — Refractor

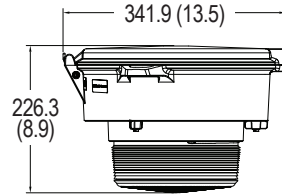

Watertight Pendant Mount — Globe

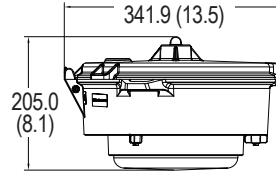

Watertight Pendant Mount — Refractor

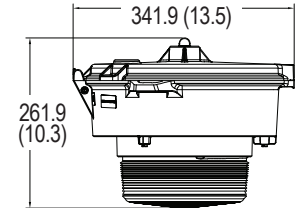

Pendant Cone Mount — Globe

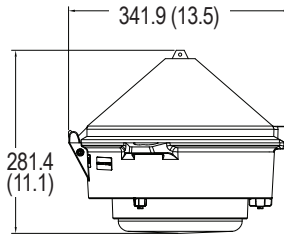

Pendant Cone Mount — Refractor

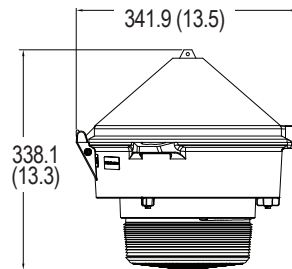

Ceiling Mount — Globe

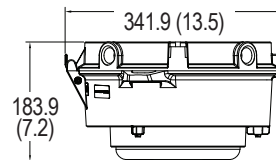

Ceiling Mount — Refractor

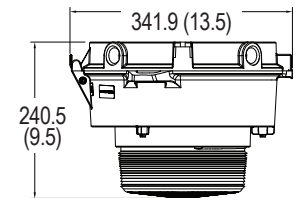

25° Stanchion Mount — Globe

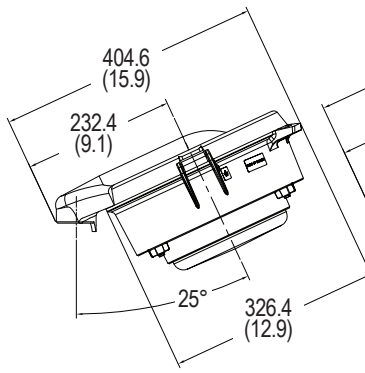

25° Stanchion Mount — Refractor

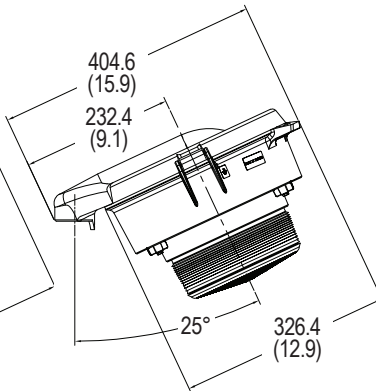

90° Stanchion Mount — Globe

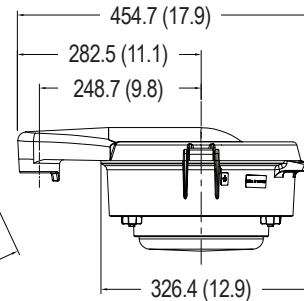

90° Stanchion Mount — Refractor

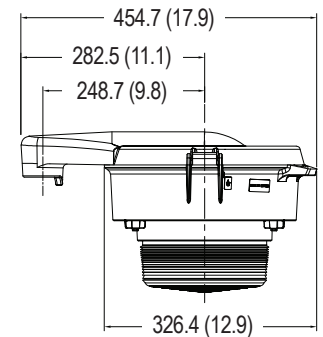

Trunnion Mount — Globe

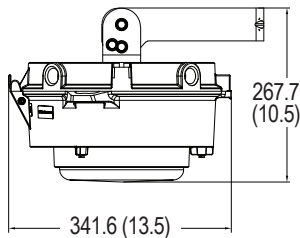

Trunnion Mount — Refractor

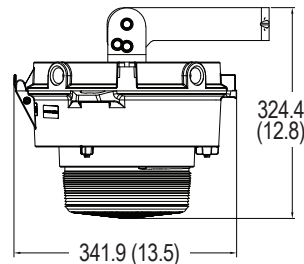

Wall Mount — Globe

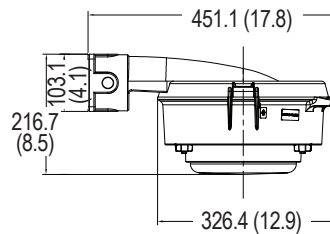

Wall Mount — Refractor

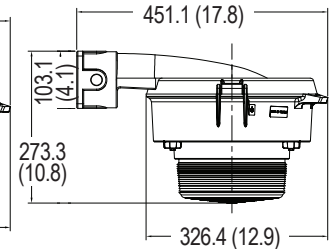

⌘ Use of fuse voids Marine Outside Type (Salt Water) rating.

Lighting

Industrial Mercmaster™ LED Low Profile Series Luminaires

Standard or with Emergency Battery Backup
Ordinary Locations

NEC/CEC Standard Model: Type 3R, 4, 4X | IP66 | IP67 | Suitable for Use in Wet Locations | Marine Outside Type (Salt Water) ⚠
 NEC/CEC Emergency Battery Backup Model: Type 3R, 4, 4X | IP66 | IP67 | Suitable for Use in Wet Locations | Marine Outside Type (Salt Water) ⚠
 IECCE CB Standard Model: IK08
 Notable: American Bureau of Shipping (ABS) Certified | International Dark Sky (IDA) Approved (Standard Model Only) | 10G Vibration

Dimensions in Millimeters (Inches) — All Models — Driver Housing

With Polycarbonate Globe — All Models

With Short Prismatic Glass Refractor — Standard Model

Dimensions in Millimeters (Inches) — All Models with Polycarbonate Globe — Standard Model with Short Prismatic Glass Refractor

Mercmaster II Adapter — Ceiling or Pendant — Globe

Mercmaster II Adapter — Ceiling or Pendant — Refractor

Mercmaster II Adapter — Stanchion or Wall — Globe

Mercmaster II Adapter — Stanchion or Wall — Refractor

Crouse-Hinds™ + Adapter — Ceiling or Pendant — Globe

Crouse-Hinds™ + Adapter — Ceiling or Pendant — Refractor

Crouse-Hinds™ + Adapter — Stanchion or Wall — Globe

Crouse-Hinds™ + Adapter — Stanchion or Wall — Refractor

Killark™ ♦ Adapter — Globe

Killark™ ♦ Adapter — Refractor

Luminaire Weights — All Models

Description	Weight kg (lb)
Standard Model Driver Housing	4.6 (10.10)
Emergency Battery Backup Model Driver Housing	5.8 (13.80)

♦ Killark is a registered trademark of Hubbell Incorporated.

† Crouse-Hinds is a registered trademark of Cooper Industries, Inc., a wholly owned subsidiary of the Eaton Corporation plc.

⚠ Use of fuse voids Marine Outside Type (Salt Water) rating.

A172 **EMERSON**

Visit our website at www.masteringled.com.
 Contact us at (800) 621-1506 or +33 3 22 54 13 90. | © June 2024

APPLETON

Industrial Mercmaster™ LED Low Profile Series Luminaires

Standard

Ordinary Locations

NEC/CEC Standard Model: Type 3R, 4, 4X | IP66 | IP67 | Suitable for Use in Wet Locations | Marine Outside Type (Salt Water) ⌘

IECEE CB Standard Model: IK08

Notable: American Bureau of Shipping (ABS) Certified | International Dark Sky (IDA) Approved (Standard Model Only) | 10G Vibration

Photometric Data — DATA SHOWN IS ABSOLUTE

Type V, Clear Polycarbonate, 5000K CCT

REPORT NUMBER: IMLLED4CP5BU

Luminaire Lumens 3,198

POLAR CANDELA DISTRIBUTION

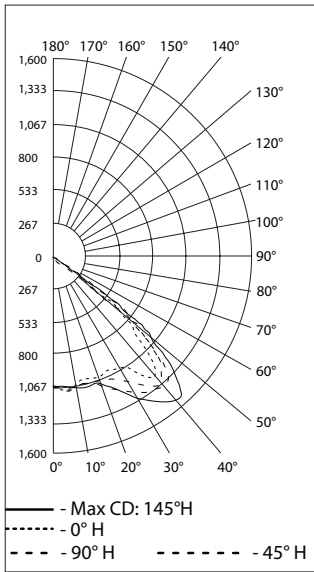

Type V, Diffused Polycarbonate, 5000K CCT

REPORT NUMBER: IMLLED4CD5BU

Luminaire Lumens 3,103

POLAR CANDELA DISTRIBUTION

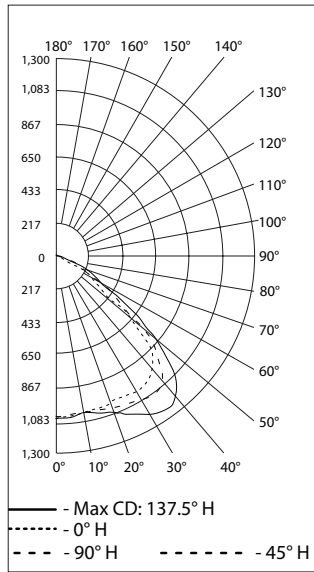

Type V, Clear Glass, 5000K CCT

REPORT NUMBER: IMLLED4CG5BU

Luminaire Lumens 3,334

POLAR CANDELA DISTRIBUTION

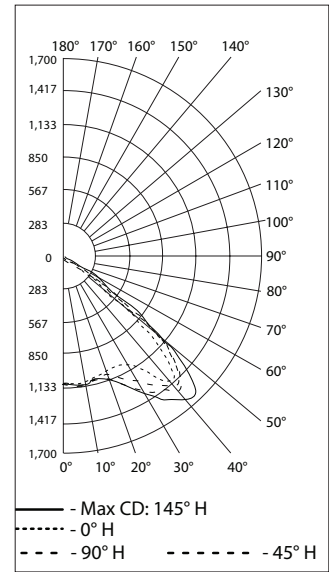

Type V, Glass Refractor, 5000K CCT

REPORT NUMBER: IMLLED4CJ5BU

Luminaire Lumens 3,020

POLAR CANDELA DISTRIBUTION

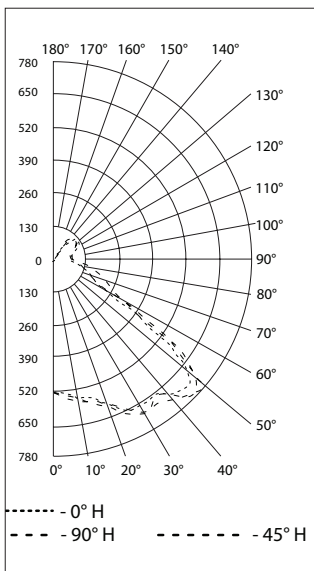

Type V, Clear Polycarbonate, 5000K CCT

REPORT NUMBER: IMLLED4CP5BU

Luminaire Lumens 4,234

POLAR CANDELA DISTRIBUTION

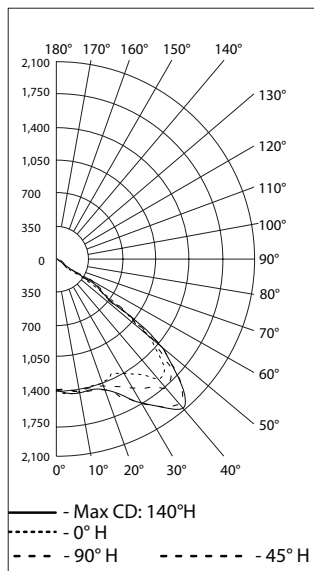

Type V, Diffused Polycarbonate, 5000K CCT

REPORT NUMBER: IMLLED4CD5BU

Luminaire Lumens 4,151

POLAR CANDELA DISTRIBUTION

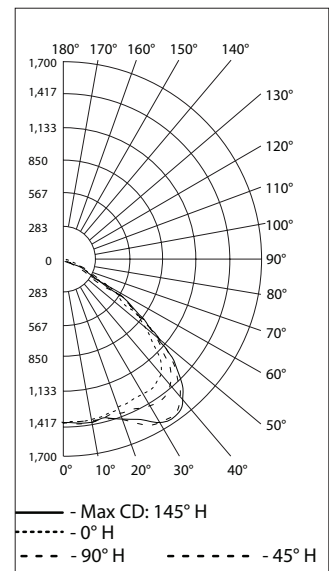

⌘ Use of fuse voids Marine Outside Type (Salt Water) rating.

Lighting

Industrial Mercmaster™ LED Low Profile Series Luminaires

Standard

Ordinary Locations

NEC/CEC Standard Model: Type 3R, 4, 4X | IP66 | IP67 | Suitable for Use in Wet Locations | Marine Outside Type (Salt Water) ⌘

IECEE CB Standard Model: IK08

Notable: American Bureau of Shipping (ABS) Certified | International Dark Sky (IDA) Approved (Standard Model Only) | 10G Vibration

Photometric Data — DATA SHOWN IS ABSOLUTE

Type V, Clear Glass, 5000K CCT

REPORT NUMBER: **IMLLED3CG5BU**

Luminaire Lumens 4,468

POLAR CANDELA DISTRIBUTION

— Max CD: 137.5° H
 - - - - 0° H
 - - - - 90° H - - - - 45° H

Type V, Glass Refractor, 5000K CCT

REPORT NUMBER: **IMLLED3CJ5BU**

Luminaire Lumens 4,020

POLAR CANDELA DISTRIBUTION

— Max CD: 140° H
 - - - - 0° H
 - - - - 90° H - - - - 45° H

Type V, Clear Polycarbonate, 5000K CCT

REPORT NUMBER: **IMLLED4CP5BU**

Luminaire Lumens 5,330

POLAR CANDELA DISTRIBUTION

— Max CD: 140° H
 - - - - 0° H
 - - - - 90° H - - - - 45° H

Type V, Diffused Polycarbonate, 5000K CCT

REPORT NUMBER: **IMLLED4CD5BU**

Luminaire Lumens 5,150

POLAR CANDELA DISTRIBUTION

— Max CD: 140° H
 - - - - 0° H
 - - - - 90° H - - - - 45° H

Type V, Clear Glass, 5000K CCT

REPORT NUMBER: **IMLLED4CG5BU**

Luminaire Lumens 5,529

POLAR CANDELA DISTRIBUTION

— Max CD: 140° H
 - - - - 0° H
 - - - - 90° H - - - - 45° H

Type V, Glass Refractor, 5000K CCT

REPORT NUMBER: **IMLLED4CJ5BU**

Luminaire Lumens 4,940

POLAR CANDELA DISTRIBUTION

— Max CD: 140° H
 - - - - 0° H
 - - - - 90° H - - - - 45° H

⌘ Use of fuse voids Marine Outside Type (Salt Water) rating.

A174 **EMERSON**

Visit our website at www.masteringled.com.
 Contact us at (800) 621-1506 or +33 3 22 54 13 90. | © June 2024

APPLETON

Industrial Mercmaster™ LED Low Profile Series Luminaires

Standard

Ordinary Locations

NEC/CEC Standard Model: Type 3R, 4, 4X | IP66 | IP67 | Suitable for Use in Wet Locations | Marine Outside Type (Salt Water) ⌘

IECEE CB Standard Model: IK08

Notable: American Bureau of Shipping (ABS) Certified | International Dark Sky (IDA) Approved (Standard Model Only) | 10G Vibration

Photometric Data — DATA SHOWN IS ABSOLUTE

Type V, Clear Polycarbonate, 5000K CCT

REPORT NUMBER: IMLLED2CP5BUH+EMR

Luminaire Lumens 1,404

POLAR CANDELA DISTRIBUTION

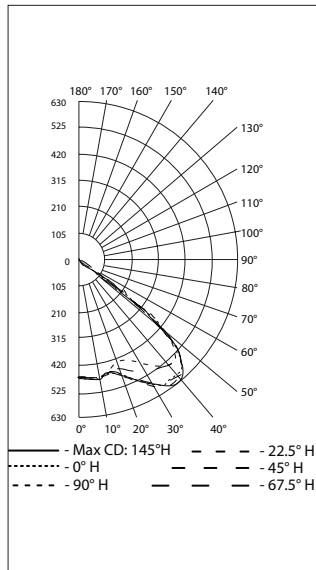

Type V, Diffused Polycarbonate, 5000K CCT

REPORT NUMBER: IMLLED2CD5BUH+EMR

Luminaire Lumens 1,369

POLAR CANDELA DISTRIBUTION

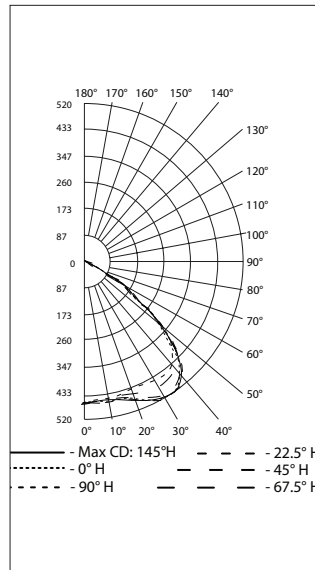

Type V, Clear Glass, 5000K CCT

REPORT NUMBER: IMLLED2CG5BUH+EMR

Luminaire Lumens 1,460

POLAR CANDELA DISTRIBUTION

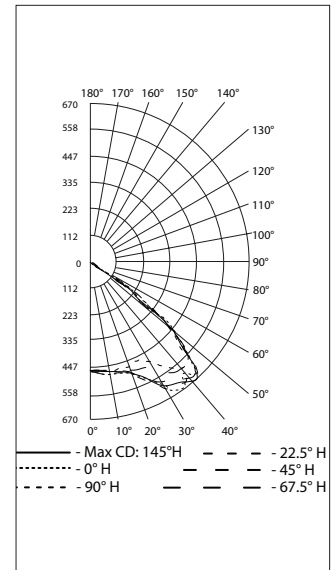

Type V, Clear Glass, 4000K CCT

REPORT NUMBER: IMLLED4NG5BUH+EMR

Luminaire Lumens 1,330

POLAR CANDELA DISTRIBUTION

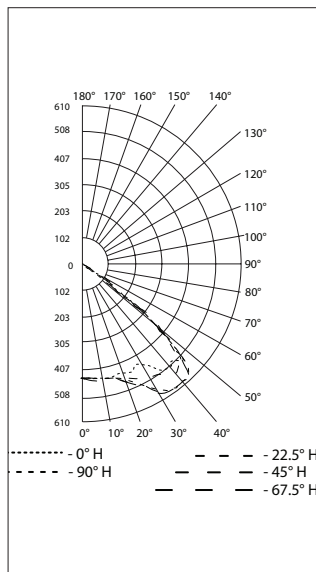

Type V, Clear Glass, 3000K CCT

REPORT NUMBER: IMLLED4WG5BUH+EMR

Luminaire Lumens 1,207

POLAR CANDELA DISTRIBUTION

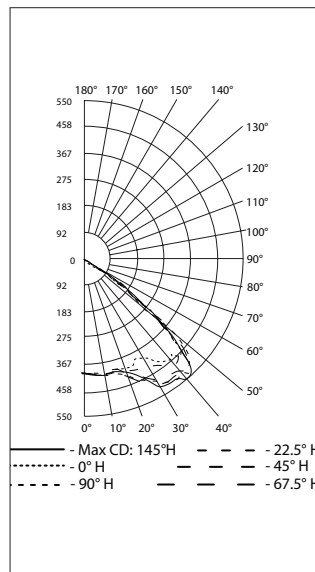

⌘ Use of fuse voids Marine Outside Type (Salt Water) rating.