

Industrial Areamaster™ Generation 2 and High Lumen LED Series Luminaires

Floodlight

Ordinary Locations

NEC/CEC/NOM: Type 3R, 4, 4X | IP66/67 | Marine outside type (salt water) for USA Only | Wet locations
 IEC/CEB: IK08 | IP66
 Markings: CE | UKCA
 Notable: American Bureau of Shipping (ABS) Certified | 10G Vibration

Applications

- Powerful, efficient, weatherproof lighting fixtures suitable for use in a wide range of industrial areas, for example:
 - Steel Production Plants
 - Power Generation Facilities
 - Foundries
 - Cement, Stone and Sand Plants
 - Pulp and Paper Mills
 - Ship Building and Shipping Ports
 - Storage Areas
 - Security Lighting
 - Hydrogen and Biofuels plants
 - LNG (Liquid Natural Gas) plants
 - Other areas where corrosive, wet, dirty and tough environments are a problem
- IP66/IP67, Type 4X, marine and wet locations.
- Locations requiring dependable, consistent lighting in extreme hot/cold temperature environments.
 - 40 °C to +65 °C (-40 °F to +149 °F) ambient temperature range.
 - 40 °C to +55 °C (-40 °F to +131 °F) for high lumen IAMLHL3 output.
 - 55 °C (-67 °F) Cold Start option available for BU voltages only.
 See Catalog Numbering Guide for more details.

Features

- Six lumen outputs provide up to 38,000 lumens.

Nominal Lumens ①	HID Equivalent	Model Number
9,500	175W-250W	IAMLGL6
15,000	250W-400W	IAMLGL7
19,500	400W-750W	IAMLGL8
24,000	1000W	IAMLHL1
30,000	1000-1500W	IAMLHL2
38,000	1500W	IAMLHL3

- Choice of optics for optimal light distribution in a variety of applications.
- Separate field wiring compartment with screw terminal block for easy and secure connection can accept 0.14 - 6 mm² (26 - 10 AWG) wire.
- Wiring compartment has two 3/4" NPT entries in bottom and one 3/4" NPT entry on top. Optional M20 metric adapters available.
- High Bay mounting achieved by using 3/4" NPT threaded non-penetrating blind hold centered in top of luminaire with integral set screw. Wire via wiring compartment.
- Yoke bracket is designed to accommodate traditional Areamaster brackets and slipfitters for easy retrofit. Optional stainless steel yoke bracket is available.
- Choice of color temperature (CCT): 5000K (70 CRI) cool white, 4000K (80 CRI) neutral white, 3000K (80 CRI) warm white, 1800K (70 CRI), or Amber (56 CRI).
- L70 Ratings:

+25 °C (+77 °F)	Reported	> 60,000 hours
Ambient Temperature	Calculated	> 200,000 hours
+65 °C (+149 °F)	Reported	> 60,000 hours
Ambient Temperature	Calculated	> 135,000 hours
- Rugged and compact housing with superior thermal design translates to long luminaire life.
- Heavy duty, high temperature silicone rubber gaskets.
- 0-10 Vdc Dimming standard for all configurations.
- Thermal shock and impact resistant clear or frosted glass lens.



IAMLG

IAMLH

- Standard 6 kV/3 kA surge protection. Optional 10 kV/5 kA additional surge protection available.
- Captive fasteners secure one piece lens.
- Field replaceable LED driver and lens cover.
- Photometric data and electronic drawings available upon request.

Warranty ②

- 10 year standard warranty.

Controls

- Dimming:
 - Luminaire has a two-wire, 0-10Vdc variable dimming input port for controlling the light output - for BU voltages only.
 - Standard operating temperature models: from 10% to 100% of the rated lumen output.
 - Cold temperature option models: from 0% to 100% of the rated lumen output.
- Group Lighting Controls:
 - Simplify installation of energy saving lighting controls.
 - Control up to 10 luminaires over a distance of 60 meters (200 ft) with Mercmaster Connect LED integrated dimming controller.
 - Daisy chain the luminaires on the same circuit breaker by wiring the 0-10V dimming leads to the Connected luminaire. Enable the Mercmaster Connect's advanced capabilities to extend daylight harvesting (adjustable output), motion sensing (up to 12 meters [40 ft]) and scheduling features (up to 4 time periods per day) with the group of lights.
 - Optionally commission and monitor the group of lights remotely via our Plantweb Insight™ Connected Lighting App.

Options

- Improved safety cable design with multiple retention points, *purchase separately*.
- Guard and visor available, *purchase separately*.
- Slip-fitters and mounting brackets available for easy pole or wall mounting.
- Stainless steel yoke bracket.
- 10 kV/5 kA Surge Protection
- For custom paint colors, contact your Appleton Sales Representative. Minimum quantity applies.

Standard Materials

- Housing and lens cover: copperfree (4/10 of 1% max.) aluminum
- Gaskets: silicone rubber
- Yoke: zinc plated steel
- Bolts: stainless steel
- Close up plugs: (2) aluminum provided
- Guard and safety cable: stainless steel
- Visor: Aluminum

Standard Finishes

- Housing, lens cover, visor and yoke mount: architectural bronze polyester

① Nominal lumen value for 5000K, NEMA Tx7, with clear glass. Detailed lumen information provided in tables.

② For warranty details go to www.appleton.emerson.com.

Industrial Areamaster™ Generation 2 and High Lumen LED Series Luminaires

Floodlight

Ordinary Locations

NEC/CEC/NOM: Type 3R, 4, 4X | IP66/67 | Marine outside type (salt water) for USA Only | Wet locations

IECEE CB: IK08 | IP66

Markings: CE | UKCA

Notable: American Bureau of Shipping (ABS) Certified | 10G Vibration

NEC/CEC Certifications and Compliances

- UL Standards: UL1598; UL1598A; UL 8750
- CSA Standards: CSA C22.2 No. 250.0
- cETLus 104364566CHI-001, 104364566CHI-002
- Vibration Rating: 10G, 10 hours, 3 axis at first mode resonant frequency

NOM: Norma Oficial Mexicana

- NOM-003-SCFI-2014 (NMX-J-307-ANCE-2017)
- NOM Certificate: ULM-NOM-15621

IECEE CB Certificates and Compliances

- IEC 60598-1, IEC 60598-2-1, and IEC 60598-2-5
- IECEE CB Certificates: CB 164460-80075815 and CB 164460-80075818
- Index of Protection according to EN/IEC 60529: IP66
- Impact Resistance (shock): IK08
- Photobiological Safety, IEC 62778 and IEC 62471: Risk Group 1 (RG1)

CE and UKCA Marking

- Safety: EN 60598-1, EN 60598-2-1, and EN 60598-2-5
- EMC: EN 61547, 61000-6-2, 61000-6-4, 61000-3-2; CISPR 15

ABS Certifications

IAMLG and IAMLH: 23-2443580-PDA

DesignLights™ Consortium

- Check DLC QPL for current list of products.

Related Products

- Areamaster Generation 2 and High Lumen LED Luminaires
- Round Tapered Steel Poles
- Hinged Steel Poles
- Square Tapered Steel Poles
- Square Steel Poles
- Floodlight Mounting Brackets

Illustrated Features

Light Where You Need It

Choose from **3 color temperatures** and a **variety of secondary optics** to put light where your application needs it most. Unsure of which optic is best for your job? Contact your sales representative to get a free 3D Dialux simulation.

The Right Beam Pattern for Your Application

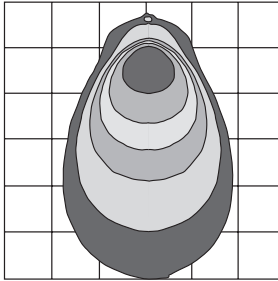

NEMA 3x3 – Very Narrow, spot type forward intensity focus. Enables highest mounting heights (30 m / 100 ft +) while maintaining delivered light on surface (footcandles/lux).

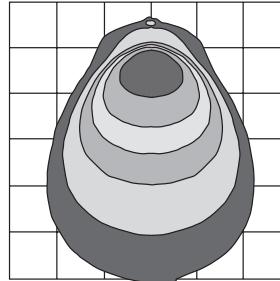

NEMA 5x5 – Narrow, spot type forward intensity focus. Enables higher mounting heights (15 m / 50 ft +) while maintaining delivered light on surface (footcandles/lux).

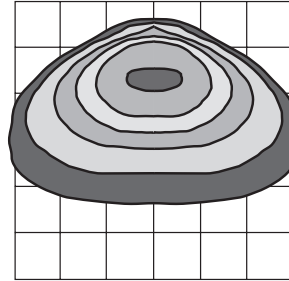

NEMA 7x6 – Mimics traditional HID light distribution. Light intensity is directed forward and side-to-side to maximize spacing between luminaires.

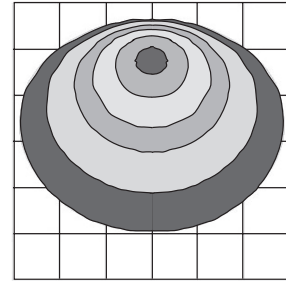

NEMA 7x7 – Uniform light spread, perfect for most typical flood lighting applications.

Robust Design

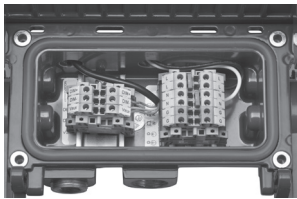

Front-Facing Wiring Compartment:

Gasketed front wiring compartment with screw terminal block, and captive screws offers unmatched installation ease and convenience.

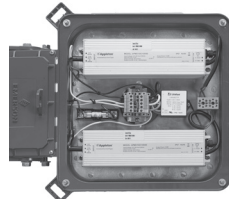

Replaceable Drivers:

Easy to access, field replaceable drivers extend the useful life of your luminaire up to 200,000 hours or more.

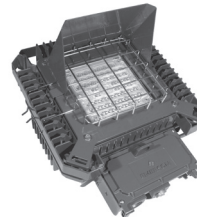

Visor and Guard:

Comply with light pollution regulations or control light spread with a visor. Protect the lens with a guard.

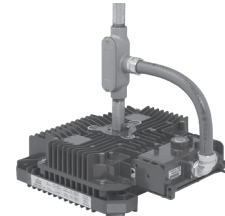

High Bay Mount:

Use 3/4" NPT threaded non-penetrating blind hold centered in top of luminaire with integral set screw. Wire via wiring compartment.

Industrial Areamaster™ Generation 2 and High Lumen LED Series Luminaires

Floodlight

Ordinary Locations

NEC/CEC/NOM: Type 3R, 4, 4X | IP66/67 | Marine outside type (salt water) for USA Only | Wet locations

IECEE CB: IK08 | IP66

Markings: CE | UKCA

Notable: American Bureau of Shipping (ABS) Certified | 10G Vibration

Order Using Catalog Numbering Guide — Industrial Areamaster™ Generation 2 Series Luminaires — Low Lumen Model

<p>IAMLG</p> <p>Series Prefix: IAMLG: Industrial Areamaster Generation 2 LED</p>	<p>L7</p> <p>Lumen Level: ① L6 - 9,500 L7 - 15,000 L8 - 19,500</p>	<p>C</p> <p>Color Temperature (CCT): C - 5000K (70 CRI) N - 4000K (80 CRI) W - 3000K (80 CRI) S - 1800K (70 CRI) A - Amber (56 CRI)</p>	<p>G</p> <p>Diffusion: G - Clear Glass F - Frosted Glass D - Diffused Polycarbonate ②</p>	<p>Z</p> <p>Beam Spread: 6 - NEMA 7x7 (non-optic) 7 - NEMA 7x6</p>	<p>BU</p> <p>Voltage: BU - 120-277 Vac, 50/60 Hz, 125-300 Vdc BH - 347-480 Vac, 50/60 Hz ③</p>	<p>F</p> <p>Fusing Options: Blank - No Fusing F - Fusing ④</p>	<p>S</p> <p>Surge Options: Blank - 6 kV Surge Protection (Standard) S - 10 kV Surge Protection ⑤</p>	<p>M</p> <p>Metric Adapter Options: Blank - No Metric Cable Entry Adapter M - M20 Metric Cable Entry Adapter (Quantity: 1) ⑥</p>	<p>C</p> <p>Cold Temperature Options: Blank - Standard Temperature (-40 °C) C - Cold Temperature (-55 °C) ⑦</p>	<p>P</p> <p>Pre-Wired Options: ⑧ Blank - No Pre-wired options P - Pre-wired (10 Foot Cord; 3 Conductors; Power without Dimming) D - Pre-wired (10 Foot Cord; 5 Conductors; Power and Dimming)</p>
-----------------------------------------------------------------------------------------------------	---------------------------------------------------------------------------------------	------------------------------------------------------------------------------------------------------------------------------------------------------------------------	----------------------------------------------------------------------------------------------------------------------	---------------------------------------------------------------------------------------	---------------------------------------------------------------------------------------------------------------------------	-------------------------------------------------------------------------------	---------------------------------------------------------------------------------------------------------------------------------	-------------------------------------------------------------------------------------------------------------------------------------------------------------	------------------------------------------------------------------------------------------------------------------------------------------------	----------------------------------------------------------------------------------------------------------------------------------------------------------------------------------------------------------------------------------------------------------

① All lumen values are typical (tolerance +/- 10%).

② Diffused Polycarbonate lens available for NEC/CEC only. Diffused Polycarbonate lens not available with Cold Start option.

③ BH voltage available for NEC/CEC only. BH voltage not available with Cold Start option. Dimming not available with BH voltage.

④ Use of fuse voids Marine rating. Fusing available for NEC/CEC only. Fusing not available with Cold Start option.

⑤ 10kV Surge Protection not available with Cold Start option.

⑥ M20 Metric Cable Entry Adapter not available with Pre-Wired options.

⑦ Cold Start option available for NEC/CEC only. Cold Start option not available with Diffused Polycarbonate lens, BH voltage, Fusing or 10kV Surge Protection.

⑧ Pre-Wiring available for NEC/CEC only. Pre-Wiring not available with Metric Adapter option. Cord grip used with Pre-Wiring option is Type 3R rated. IP66/IP67 and Marine rating is not available with Pre-Wiring option.

Industrial Areamaster™ Generation 2 and High Lumen LED Series Luminaires

Floodlight

Ordinary Locations

NEC/CEC/NOM: Type 3R, 4, 4X | IP66/67 | Marine outside type (salt water) for USA Only | Wet locations

IECEE CB: IK08 | IP66

Markings: CE | UKCA

Notable: American Bureau of Shipping (ABS) Certified | 10G Vibration

Order Using Catalog Numbering Guide — Industrial Areamaster™ LED Series Luminaires — High Lumen Model

IAMLH	L2	C	G	Z	BU	F	S	M	C	P
Series Prefix: IAMLH: Industrial Areamaster Generation 2 HL LED	Lumen Level: ① L1 - 24,000 L2 - 30,000 L3 - 38,000	Color Temperature (CCT): C - 5000K (70 CRI) N - 4000K (80 CRI) W - 3000K (80 CRI) S - 1800K (70 CRI) A - Amber (56 CRI)	Diffusion: G - Clear Glass F - Frosted Glass	Beam Spread: 3 - NEMA 3x3 5 - NEMA 5x5 6 - NEMA 7x7 (non-optic) 7 - NEMA 7x6	Voltage: BU - 120-277 Vac, 50/60 Hz, 125-300 Vdc BH - 347-480 Vac, 50/60 Hz ②	Fusing Options: Blank - No Fusing F - Fusing ③	Surge Options: Blank - 6 kV Surge Protection (Standard) S - 10 kV Surge Protection ④	Metric Adapter Options: Blank - No Metric Cable Entry Adapter M - M20 Metric Cable Entry Adapter (Quantity: 1) ⑤	Cold Temperature Options: Blank - Standard Temperature (-40 °C) C - Cold Temperature (-55 °C) ⑥	Pre-Wired Options: ⑦ Blank - No Pre-wired options P - Pre-wired (10 Foot Cord; 3 Conductors; Power without Dimming) D - Pre-wired (10 Foot Cord; 5 Conductors; Power and Dimming)

① All lumen values are typical (tolerance +/- 10%).

② BH voltage available for NEC/CEC only. BH voltage not available with Cold Start option. Dimming not available with BH voltage.

③ Use of fuse voids Marine rating. Fusing available for NEC/CEC only. Fusing not available with Cold Start option.

④ 10kV Surge Protection not available with Cold Start option.

⑤ M20 Metric Cable Entry Adapter not available with Pre-Wired options.

⑥ Cold Start option available for NEC/CEC only. Cold Start option not available with BH voltage, Fusing or 10kV Surge Protection.

⑦ Pre-Wiring available for NEC/CEC only. Pre-Wiring not available with Metric Adapter option. Cord grip used with Pre-Wiring option is Type 3R rated. IP66/IP67 and Marine rating is not available with Pre-Wiring option.

Industrial Areamaster™ Generation 2 and High Lumen LED Series Luminaires

Floodlight

Ordinary Locations

NEC/CEC/NOM: Type 3R, 4, 4X | IP66/67 | Marine outside type (salt water) for USA Only | Wet locations

IECEE CB: IK08 | IP66

Markings: CE | UKCA

Notable: American Bureau of Shipping (ABS) Certified | 10G Vibration

Lumen Output (Efficacy) — Low Lumen Model ① 3000K, 4000K, 5000K

Model	HID Equivalency	Light Distribution Pattern	CCT (Correlated Color Temperature)	CRI (Color Rendering Index)	Lumen Output	Efficacy (lm/W)	CCT	CRI	Lumen Output	Efficacy (lm/W)	CCT	CRI	Lumen Output	Efficacy (lm/W)
Clear Glass														
IAMLGL6	175-250W	NEMA 7x6	3000K	80	7,350	105	4000K	80	8,500	121	5000K	70	9,500	136
		NEMA 7x7	3000K	80	7,650	109	4000K	80	9,000	129	5000K	70	9,900	141
IAMLGL7	250-400W	NEMA 7x6	3000K	80	11,000	99	4000K	80	12,950	117	5000K	70	14,500	131
		NEMA 7x7	3000K	80	11,500	104	4000K	80	13,650	123	5000K	70	15,000	135
IAMLGL8	400-750W	NEMA 7x6	3000K	80	14,500	95	4000K	80	16,550	109	5000K	70	18,500	122
		NEMA 7x7	3000K	80	15,000	99	4000K	80	17,550	115	5000K	70	19,500	128
Frosted Glass														
IAMLGL6	175-250W	NEMA 7x6	3000K	80	6,200	89	4000K	80	7,200	103	5000K	70	7,900	113
		NEMA 7x7	3000K	80	6,400	91	4000K	80	7,500	107	5000K	70	8,300	119
IAMLGL7	250-400W	NEMA 7x6	3000K	80	9,400	85	4000K	80	10,950	99	5000K	70	12,000	108
		NEMA 7x7	3000K	80	9,700	87	4000K	80	11,350	102	5000K	70	12,500	113
IAMLGL8	400-750W	NEMA 7x6	3000K	80	12,000	79	4000K	80	14,000	92	5000K	70	15,550	102
		NEMA 7x7	3000K	80	12,500	82	4000K	80	14,500	95	5000K	70	16,550	109
Diffused Polycarbonate														
IAMLGL6	175-250W	NEMA 7x6	3000K	80	5,950	85	4000K	80	6,950	99	5000K	70	7,700	110
		NEMA 7x7	3000K	80	6,250	89	4000K	80	7,300	104	5000K	70	8,050	115
IAMLGL7	250-400W	NEMA 7x6	3000K	80	9,000	81	4000K	80	10,550	95	5000K	70	11,700	105
		NEMA 7x7	3000K	80	9,450	85	4000K	80	11,000	99	5000K	70	12,200	110
IAMLGL8	400-750W	NEMA 7x6	3000K	80	11,500	76	4000K	80	13,500	89	5000K	70	15,000	99
		NEMA 7x7	3000K	80	12,100	80	4000K	80	14,150	93	5000K	70	15,650	103

① All lumen values are typical (tolerance +/-10%).

Industrial Areamaster™ Generation 2 and High Lumen LED Series Luminaires

Floodlight

Ordinary Locations

NEC/CEC/NOM: Type 3R, 4, 4X | IP66/67 | Marine outside type (salt water) for USA Only | Wet locations

IECEE CB: IK08 | IP66

Markings: CE | UKCA

Notable: American Bureau of Shipping (ABS) Certified | 10G Vibration

Lumen Output (Efficacy) — Low Lumen Model ① Amber, 1800K

Model	HID Equivalency	Light Distribution Pattern	CCT (Correlated Color Temperature)	CRI (Color Rendering Index)	Lumen Output	Efficacy (lm/W)	CCT	CRI	Lumen Output	Efficacy (lm/W)
Clear Glass										
IAMLGL6	175-250W	NEMA 7x6	Amber	56	5,400	78	1800K	70	6,150	89
		NEMA 7x7	Amber	56	5,900	82	1800K	70	6,700	94
IAMLGL7	250-400W	NEMA 7x6	Amber	56	8,150	73	1800K	70	9,300	84
		NEMA 7x7	Amber	56	8,550	78	1800K	70	9,800	89
IAMLGL8	400-750W	NEMA 7x6	Amber	56	10,150	67	1800K	70	11,650	77
		NEMA 7x7	Amber	56	10,450	69	1800K	70	12,250	81
Frosted Glass										
IAMLGL6	175-250W	NEMA 7x6	Amber	56	4,550	66	1800K	70	5,250	76
		NEMA 7x7	Amber	56	4,950	69	1800K	70	5,600	79
IAMLGL7	250-400W	NEMA 7x6	Amber	56	6,900	63	1800K	70	7,900	71
		NEMA 7x7	Amber	56	7,150	65	1800K	70	8,250	75
IAMLGL8	400-750W	NEMA 7x6	Amber	56	8,500	56	1800K	70	9,950	66
		NEMA 7x7	Amber	56	8,800	58	1800K	70	10,300	68
Diffused Polycarbonate										
IAMLGL6	175-250W	NEMA 7x6	Amber	56	4,300	62	1800K	70	4,950	72
		NEMA 7x7	Amber	56	4,700	66	1800K	70	5,350	75
IAMLGL7	250-400W	NEMA 7x6	Amber	56	6,600	60	1800K	70	7,500	67
		NEMA 7x7	Amber	56	6,850	62	1800K	70	7,850	71
IAMLGL8	400-750W	NEMA 7x6	Amber	56	8,050	53	1800K	70	9,450	62
		NEMA 7x7	Amber	56	8,350	55	1800K	70	9,850	65

① All lumen values are typical (tolerance +/-10%).

Industrial Areamaster™ Generation 2 and High Lumen LED Series Luminaires

Floodlight

Ordinary Locations

NEC/CEC/NOM: Type 3R, 4, 4X | IP66/67 | Marine outside type (salt water) for USA Only | Wet locations

IECEE CB: IK08 | IP66

Markings: CE | UKCA

Notable: American Bureau of Shipping (ABS) Certified | 10G Vibration

Lumen Output (Efficacy) — High Lumen Model ① 3000K, 4000K, 5000K

Model	HID Equivalency	Light Distribution Pattern	CCT (Correlated Color Temperature)	CRI (Color Rendering Index)	Lumen Output	Efficacy (lm/W)	CCT	CRI	Lumen Output	Efficacy (lm/W)	CCT	CRI	Lumen Output	Efficacy (lm/W)
Clear Glass														
IAMLHL1	1000W	NEMA 3x3	3000K	80	19,350	109	4000K	80	20,250	114	5000K	70	22,750	128
		NEMA 5x5	3000K	80	20,850	117	4000K	80	21,900	123	5000K	70	25,000	140
		NEMA 7x6	3000K	80	19,000	107	4000K	80	20,500	115	5000K	70	23,000	129
		NEMA 7x7	3000K	80	20,100	113	4000K	80	21,300	120	5000K	70	24,250	136
IAMLHL2	1000-1500W	NEMA 3x3	3000K	80	23,450	106	4000K	80	24,600	111	5000K	70	27,500	124
		NEMA 5x5	3000K	80	25,500	115	4000K	80	26,700	120	5000K	70	30,000	135
		NEMA 7x6	3000K	80	23,200	105	4000K	80	25,000	113	5000K	70	27,950	126
IAMLHL3	1500W	NEMA 7x7	3000K	80	24,650	111	4000K	80	26,100	118	5000K	70	29,750	134
		NEMA 3x3	3000K	80	29,500	99	4000K	80	30,950	104	5000K	70	34,750	117
		NEMA 5x5	3000K	80	32,000	107	4000K	80	33,600	113	5000K	70	37,500	126
		NEMA 7x6	3000K	80	29,300	98	4000K	80	31,500	106	5000K	70	35,350	119
IAMLHL1	1000W	NEMA 7x7	3000K	80	31,000	104	4000K	80	32,800	110	5000K	70	37,400	126
		NEMA 3x3	3000K	80	17,200	97	4000K	80	17,950	101	5000K	70	20,000	112
		NEMA 5x5	3000K	80	18,600	104	4000K	80	19,350	109	5000K	70	21,550	121
		NEMA 7x6	3000K	80	16,150	91	4000K	80	17,300	97	5000K	70	19,500	110
IAMLHL2	1000-1500W	NEMA 7x7	3000K	80	16,850	95	4000K	80	18,000	101	5000K	70	20,500	115
		NEMA 3x3	3000K	80	21,000	95	4000K	80	21,950	99	5000K	70	24,750	111
		NEMA 5x5	3000K	80	22,650	102	4000K	80	23,600	106	5000K	70	26,000	117
		NEMA 7x6	3000K	80	19,600	88	4000K	80	21,000	95	5000K	70	23,700	107
IAMLHL3	1500W	NEMA 7x7	3000K	80	20,550	93	4000K	80	21,950	99	5000K	70	25,000	113
		NEMA 3x3	3000K	80	26,400	89	4000K	80	27,500	92	5000K	70	31,000	104
		NEMA 5x5	3000K	80	28,600	96	4000K	80	29,750	100	5000K	70	33,500	112
		NEMA 7x6	3000K	80	24,750	83	4000K	80	26,550	89	5000K	70	29,950	101
IAMLHL3	1500W	NEMA 7x7	3000K	80	26,000	87	4000K	80	27,700	93	5000K	70	31,500	106

① All lumen values are typical (tolerance +/-10%).

Industrial Areamaster™ Generation 2 and High Lumen LED Series Luminaires

Floodlight

Ordinary Locations

NEC/CEC/NOM: Type 3R, 4, 4X | IP66/67 | Marine outside type (salt water) for USA Only | Wet locations

IECEE CB: IK08 | IP66

Markings: CE | UKCA

Notable: American Bureau of Shipping (ABS) Certified | 10G Vibration

Lumen Output (Efficacy) — High Lumen Model ① Amber, 1800K

Model	HID Equivalency	Light Distribution Pattern	CCT (Correlated Color Temperature)	CRI (Color Rendering Index)	Lumen Output	Efficacy (lm/W)	CCT	CRI	Lumen Output	Efficacy (lm/W)
Clear Glass										
IAMLHL1	1000W	NEMA 3x3	Amber	56	14,050	76	1800K	70	14,450	78
		NEMA 5x5	Amber	56	14,350	78	1800K	70	15,900	86
		NEMA 7x6	Amber	56	13,350	73	1800K	70	15,050	82
		NEMA 7x7	Amber	56	14,150	77	1800K	70	15,850	86
IAMLHL2	1000-1500W	NEMA 3x3	Amber	56	16,200	73	1800K	70	16,850	76
		NEMA 5x5	Amber	56	16,700	75	1800K	70	18,600	83
		NEMA 7x6	Amber	56	15,600	71	1800K	70	17,550	79
		NEMA 7x7	Amber	56	16,550	75	1800K	70	18,500	83
IAMLHL3	1500W	NEMA 3x3	Amber	56	18,750	63	1800K	70	19,850	67
		NEMA 5x5	Amber	56	19,850	67	1800K	70	21,850	73
		NEMA 7x6	Amber	56	18,450	62	1800K	70	20,700	69
		NEMA 7x7	Amber	56	19,500	66	1800K	70	21,800	73
Frosted Glass										
IAMLHL1	1000W	NEMA 3x3	Amber	56	12,500	68	1800K	70	12,850	70
		NEMA 5x5	Amber	56	12,650	69	1800K	70	14,200	77
		NEMA 7x6	Amber	56	11,350	62	1800K	70	13,000	71
		NEMA 7x7	Amber	56	12,000	66	1800K	70	13,500	73
IAMLHL2	1000-1500W	NEMA 3x3	Amber	56	14,250	64	1800K	70	15,000	67
		NEMA 5x5	Amber	56	14,850	67	1800K	70	16,500	74
		NEMA 7x6	Amber	56	13,250	60	1800K	70	15,200	68
		NEMA 7x7	Amber	56	14,050	63	1800K	70	15,800	71
IAMLHL3	1500W	NEMA 3x3	Amber	56	16,950	57	1800K	70	17,650	59
		NEMA 5x5	Amber	56	17,400	59	1800K	70	19,500	65
		NEMA 7x6	Amber	56	15,800	53	1800K	70	17,900	60
		NEMA 7x7	Amber	56	16,450	55	1800K	70	18,600	62

① All lumen values are typical (tolerance +/-10%).

Industrial Areamaster™ Generation 2 and High Lumen LED Series Luminaires

Floodlight

Ordinary Locations

NEC/CEC/NOM: Type 3R, 4, 4X | IP66/67 | Marine outside type (salt water) for USA Only | Wet locations

IECEE CB: IK08 | IP66

Markings: CE | UKCA

Notable: American Bureau of Shipping (ABS) Certified | 10G Vibration

Electrical Specifications ①

Model	Voltage	Input Power (Watts)	Input Current (Amps)	Power Factor (PF)	Total Harmonic Distortion (THD)
Low Lumen Model					
IAMLGL6	120 Vac	73	0.62	>.9	<20%
	277 Vac	71	0.27		
	125 Vdc	69	0.55	N/A	N/A
	300 Vdc	68	0.23		
	347 Vac	71	0.21	>.9	<20%
	480 Vac	71	0.16		
IAMLGL7	120 Vac	111	0.94	>.9	<20%
	277 Vac	106	0.43		
	125 Vdc	113	0.90	N/A	N/A
	300 Vdc	111	0.37		
	347 Vac	115	0.33	>.9	<20%
	480 Vac	115	0.25		
IAMLGL8	120 Vac	154	1.30	>.9	<20%
	277 Vac	146	0.56		
	125 Vdc	156	1.25	N/A	N/A
	300 Vdc	152	0.51		
	347 Vac	150	0.43	>.9	<20%
	480 Vac	149	0.32		
High Lumen Model					
IAMLHL1	120 Vac	180	1.52	>.9	<20%
	277 Vac	176	0.67		
	125 Vdc	172	1.38	N/A	N/A
	300 Vdc	170	0.57		
	347 Vac	179	0.52	>.9	<20%
	480 Vac	179	0.39		
IAMLHL2	120 Vac	231	1.94	>.9	<20%
	277 Vac	231	0.88		
	125 Vdc	220	1.76	N/A	N/A
	300 Vdc	217	0.72		
	347 Vac	219	0.64	>.9	<20%
	480 Vac	219	0.47		
IAMLHL3	120 Vac	317	2.67	>.9	<20%
	277 Vac	303	1.15		
	125 Vdc	305	2.44	N/A	N/A
	300 Vdc	298	0.99		
	347 Vac	299	0.87	>.9	<20%
	480 Vac	298	0.63		

Note: Surge Protection: Integral 6 kV surge protection. Option for up to 10 kV surge protection.

① All values are typical (tolerance +/-10%).

Industrial Areamaster™ Generation 2 and High Lumen LED Series Luminaires

Floodlight

Ordinary Locations

NEC/CEC/NOM: Type 3R, 4, 4X | IP66/67 | Marine outside type (salt water) for USA Only | Wet locations

IECEE CB: IK08 | IP66

Markings: CE | UKCA

Notable: American Bureau of Shipping (ABS) Certified | 10G Vibration

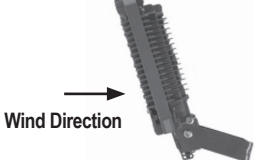
Luminaire Category		Frontal Projected Area (FPA) ft ²	Drag Coefficient (DC)	Effective Projected Area (EPA) = FPA*DC ft ²
Low Lumen Model — IAMLG				
90° to Ground-Worst Case Mounting		1.52	1.20	1.82
45° to Ground-Standard Mounting		1.07	1.2	1.28
High Lumen Model — IAMLH				
90° to Ground-Worst Case Mounting		2.04	1.20	2.45
45° to Ground-Standard Mounting		1.44	1.20	1.73

Industrial Areamaster™ Generation 2 and High Lumen LED Series Luminaires

Floodlight

Ordinary Locations







NEC/CEC/NOM: Type 3R, 4, 4X | IP66/67 | Marine outside type (salt water) for USA Only | Wet locations

IECEE CB: IK08 | IP66

Markings: CE | UKCA

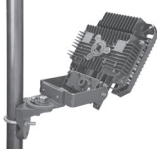
Notable: American Bureau of Shipping (ABS) Certified | 10G Vibration

Accessories and Replacement Parts

	Description	Weight in kg (lbs)	Catalog Number
Crossarm Mounting Bracket			
	<p>Has 180° horizontal adjustment — degree marked. Facilitates mounting floodlight to crossarm or other flat surface, or to GAM8WB. Includes floodlight yoke bolts. Malleable iron, zinc plated, chromate sealed, architectural bronze polyester finish.</p>	1.4 (3.1)	GAM8CA
Pipe or Wall Mount Bracket			
	<p>Used with GAM8CA. Clamps to 1" to 2-1/2" pipe, vertical or horizontal, or mounts on flat surfaces. Includes U-bolt and crossarm bracket bolts. Malleable iron, zinc plated, chromate sealed, with architectural bronze polyester finish.</p>	2.9 (6.4)	GAM8WB
	<p><i>Crossarm Mounting Bracket (GAM8CA) used with Pipe or Wall Mount Bracket (GAM8WB).</i></p>		
Poletop Slip-Fitter			
	<p>Slip-fits 1" or 1-1/2" pipe size poletop tenons. Includes floodlight yoke bolts, 3 locking bolts, and cord grip. Body is malleable iron-zinc plated, chromate sealed, with cast aluminum cap. Assembly has architectural bronze polyester finish.</p>	2.4 (5.3)	AMLEDSF1
Poletop Slip-Fitter			
	<p>Slip-fits 1-1/2" or 2" pipe size poletop tenons. Includes floodlight yoke bolts, 3 locking bolts, and cord grip. Body is malleable iron-zinc plated, chromate sealed, with cast aluminum cap. Assembly has architectural bronze polyester finish.</p>	2.4 (5.3)	GSF20
Poletop Slip-Fitter			
	<p>Slip-fits 2" or 2-1/2" poletop tenons. Includes floodlight yoke bolts, 3 locking bolts, and cord grip. Malleable iron, zinc plated, chromate sealed, with architectural bronze polyester finish.</p>	2.8 (6.2)	GAM8SF

Industrial Areamaster™ Generation 2 and High Lumen LED Series Luminaires

Floodlight

Ordinary Locations







NEC/CEC/NOM: Type 3R, 4, 4X | IP66/67 | Marine outside type (salt water) for USA Only | Wet locations

IECEE CB: IK08 | IP66

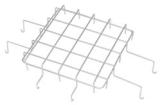
Markings: CE | UKCA

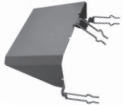
Notable: American Bureau of Shipping (ABS) Certified | 10G Vibration

Accessories and Replacement Parts

	Description	Weight in kg (lbs)	Catalog Number
Wall Mount Bracket			
	Used with GAM8SF to provide a wall mounting option. Galvanized Steel.	4.8 (10.5)	GPSWB6GAL
Wire Guard - Stainless Steel			
	IAMLGL6, IAMLGL7, IAMLGL8	0.2 (0.4)	LGGUARD
	IAMLHL1, IAMLHL2, IAMLHL3		LHGUARD
Safety Cable			
	Stainless steel - 1.22 m (4 ft)	0.2 (0.4)	LEDSC
	Stainless steel - 2.44 m (8 ft)	0.4 (0.8)	LEDSC8
Visor for Dark Sky Friendly Design - Steel with architectural bronze polyester finish			
	IAMLGL6, IAMLGL7, IAMLGL8	0.2 (0.4)	AMLGV
	IAMLHL1, IAMLHL2, IAMLHL3		AMLHV
Portable Floodlight Base			
	Portable floodlight base for temporary lighting applications. To be used with wire guard. Malleable iron with architectural bronze polyester finish.	2.4 (5.2)	GAMPFB
Replacement Covers/Lenses			
	Clear Glass — IAMLGL6, IAMLGL7, IAMLGL8	2.2 (4.8)	AMLGCLEAR
	Frosted Glass — IAMLGL6, IAMLGL7, IAMLGL8	2.0 (4.5)	AMLG Frost
	Diffused Polycarbonate — IAMLGL6, IAMLGL7, IAMLGL8	1.6 (3.5)	AMLGDIFFP
	Clear Glass — IAMLHL1, IAMLHL2, IAMLHL3	2.4 (5.3)	AMLHCLEAR
	Frosted Glass — IAMLHL1, IAMLHL2, IAMLHL3	2.4 (5.3)	AMLHFROST
Yoke Mount Bracket			
	Stainless Steel Yoke Mount Bracket. For installations requiring a higher degree of corrosion protection. Made with all stainless steel components, no painted finish.	1.8 (4.0)	AMLYMSS
	Architectural Bronze Replacement Yoke Bracket - Matches mounting hole pattern of Crouse-Hinds™ ± Champ FMVA and Champ Pro PFMA LED series floodlights	1.41 (3.1)	AMLYMCH

± Crouse-Hinds and Champ are registered trademarks of Cooper Industries, Inc., a wholly owned subsidiary of the Eaton Corporation plc.

Industrial Areamaster™ Generation 2 and High Lumen LED Series Luminaires

Floodlight

Ordinary Locations



NEC/CEC/NOM: Type 3R, 4, 4X | IP66/67 | Marine outside type (salt water) for USA Only | Wet locations

IECEE CB: IK08 | IP66

Markings: CE | UKCA

Notable: American Bureau of Shipping (ABS) Certified | 10G Vibration

Replacement Drivers

	Model	Voltage	Driver Wattage	Constant Current Setting	Catalog Number	
Low Lumen Model - Standard Temperature (-40 °C)						
	IAMLGL6C, IAMLGL6N, IAMLGL6W, IAMLGL6S, IAMLGL6A	BU BH	100 Watt	410mA	APMS100C105UD41 APMS100C105HD41	
	IAMLGL7W	BU BH	150 Watt	650mA	APMS150C105UD65 APMS150C105HD65	
	IAMLGL7C, IAMLGL7N, IAMLGL7S, IAMLGL7A	BU BH	150 Watt	680mA	APMS150C105UD68 APMS150C105HD68	
	IAMLGL8W	BU BH	150 Watt	890mA	APMS150C105UD89 APMS150C105HD89	
	IAMLGL8C, IAMLGL8N, IAMLGL8S, IAMLGL8A	BU BH	150 Watt	930mA	APMS150C105UD93 APMS150C105HD93	
	Cold Temperature (-55 °C)					
	IAMLGL6 - all CCTs	BU	100 Watt	410mA	APMZ100C090UD41	
	IAMLGL7 - all CCTs	BU	150 Watt	680mA	APMZ150C135UD68	
	IAMLGL8 - all CCTs	BU	150 Watt	930mA	APMZ150C135UD93	
	High Lumen Model - Standard Temperature (-40 °C)					
	IAMLHL1C, IAMLHL1N, IAMLHL1W, IAMLHL1S, IAMLHL1A	BU BH	100 Watt	530mA	APMS100C105UD53 APMS100C105HD53	
	IAMLHL2W	BU BH	150 Watt	650mA	APMS150C105UD65 APMS150C105HD65	
	IAMLHL2C, IAMLHL2N, IAMLHL2S, IAMLHL2A	BU BH	150 Watt	680mA	APMS150C105UD68 APMS150C105HD68	
	IAMLHL3W	BU BH	150 Watt	890mA	APMS150C105UD89 APMS150C105HD89	
	IAMLHL3C, IAMLHL3N, IAMLHL3S, IAMLHL3A	BU BH	150 Watt	915mA	APMS150C105UD91 APMS150C105HD91	
	Cold Temperature (-55 °C)					
	IAMLHL1 - all CCTs	BU	100 Watt	530mA	APMZ100C090UD53	
	IAMLHL2 - all CCTs	BU	150 Watt	680mA	APMZ150C135UD68	
	IAMLHL3 - all CCTs	BU	150 Watt	915mA	APMZ150C135UD93	

Luminaire Weights

Description	Weight in kg (lbs)
Low Lumen Model — IAMLGL6, IAMLGL7, IAMLGL8 Luminaires	9.8 (21.6)
High Lumen Model — IAMLHL1, IAMLHL2, IAMLHL3 Luminaires	16.1 (35.4)

Industrial Areamaster™ Generation 2 and High Lumen LED Series Luminaires

Floodlight

Ordinary Locations

NEC/CEC/NOM: Type 3R, 4, 4X | IP66/67 | Marine outside type (salt water) for USA Only | Wet locations

IECEE CB: IK08 | IP66

Markings: CE | UKCA

Notable: American Bureau of Shipping (ABS) Certified | 10G Vibration

IAMLG Dimensions in Millimeters (Inches) — Floodlight — Low Lumen Model

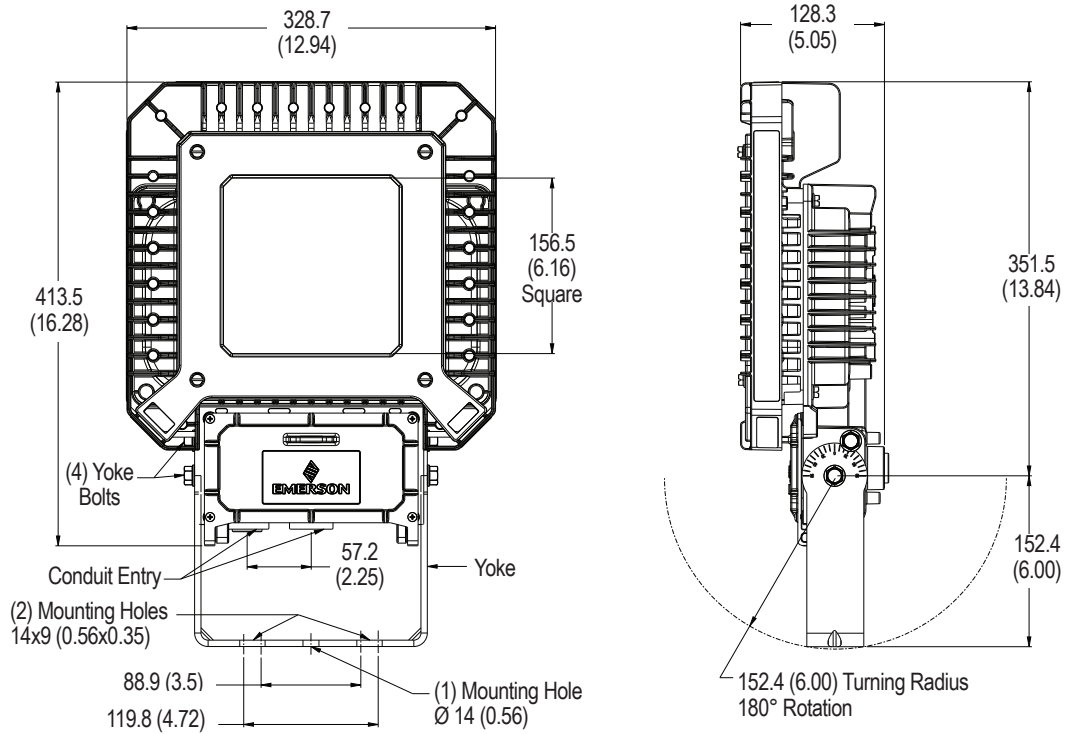

Industrial Areamaster™ Generation 2 and High Lumen LED Series Luminaires

Floodlight

Ordinary Locations

NEC/CEC/NOM: Type 3R, 4, 4X | IP66/67 | Marine outside type (salt water) for USA Only | Wet locations

IECEE CB: IK08 | IP66

Markings: CE | UKCA

Notable: American Bureau of Shipping (ABS) Certified | 10G Vibration

IAMLH Dimensions in Millimeters (Inches) — Floodlight — High Lumen Model

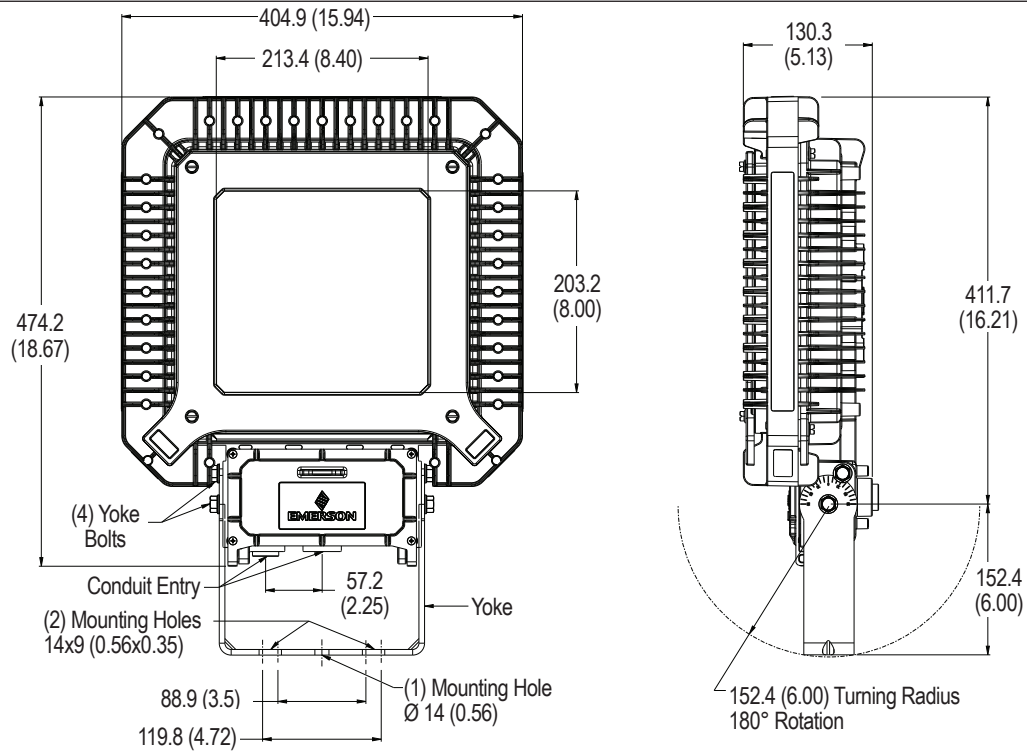

(4) 1/4-20 UNC-2B Thread

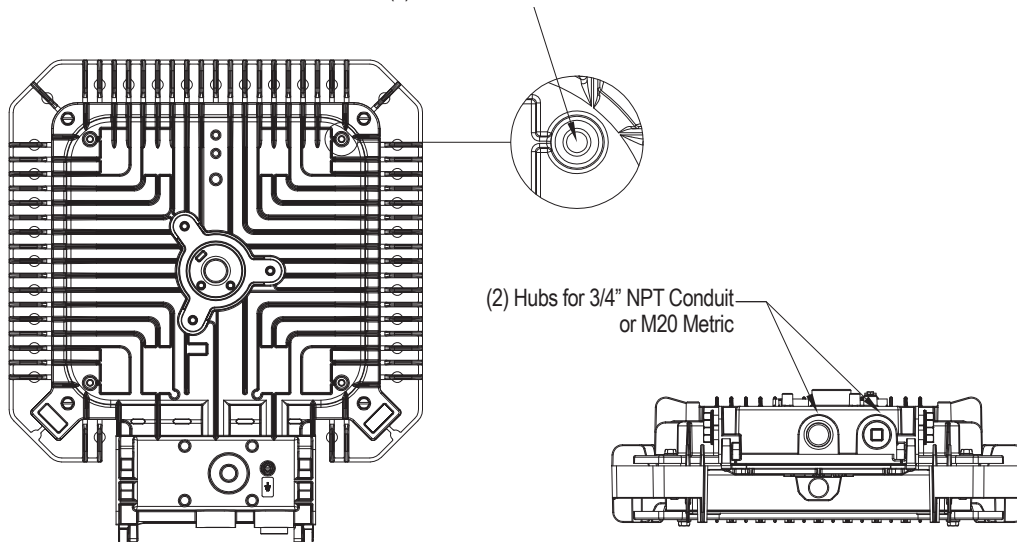

Industrial Areamaster™ Generation 2 and High Lumen LED Series Luminaires

Floodlight
Ordinary Locations

NEC/CEC/NOM: Type 3R, 4, 4X | IP66/67 | Marine outside type (salt water) for USA Only | Wet locations
IECEE CB: IK08 | IP66
Markings: CE | UKCA
Notable: American Bureau of Shipping (ABS) Certified | 10G Vibration

Photometric Data — DATA SHOWN IS ABSOLUTE

NEMA 7x7, Clear Glass, 5000K CCT
REPORT NUMBER : **IAMLGL6CG6BU**
Luminaire Lumens : 9,964 lumens

POLAR CANDELA DISTRIBUTION

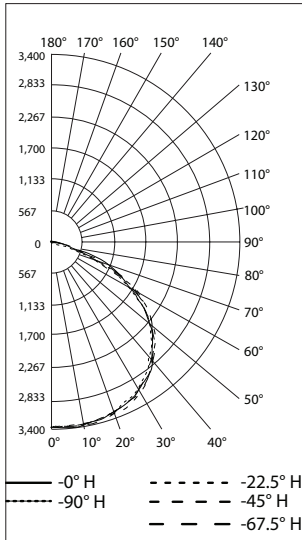

NEMA 7x7, Frosted Glass, 5000K CCT
REPORT NUMBER : **IAMLGL6CF6BU**
Luminaire Lumens : 8,115 lumens

POLAR CANDELA DISTRIBUTION

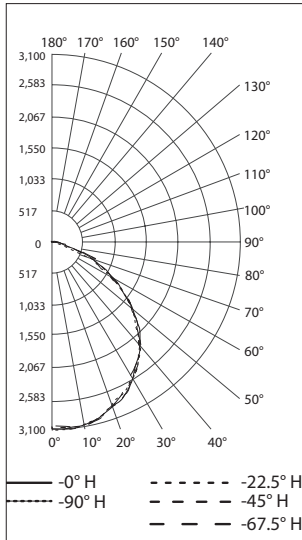

NEMA 7x7, Clear Glass, 5000K CCT
REPORT NUMBER : **IAMLGL7CG6BU**
Luminaire Lumens : 15,320 lumens

POLAR CANDELA DISTRIBUTION

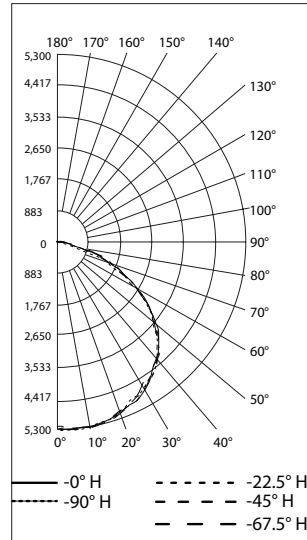

NEMA 7x7, Frosted Glass, 5000K CCT
REPORT NUMBER : **IAMLGL7CF6BU**
Luminaire Lumens : 12,782 lumens

POLAR CANDELA DISTRIBUTION

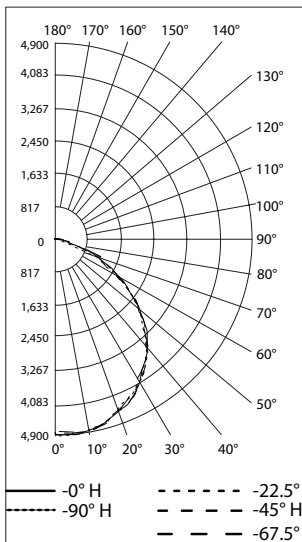

NEMA 7x7, Clear Glass, 5000K CCT
REPORT NUMBER : **IAMLGL8CG6BU**
Luminaire Lumens : 19,895 lumens

POLAR CANDELA DISTRIBUTION

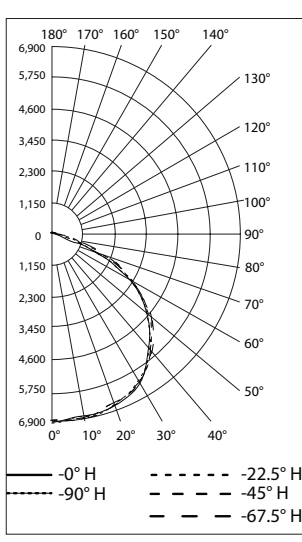

NEMA 7x7, Frosted Glass, 5000K CCT
REPORT NUMBER : **IAMLGL8CF6BU**
Luminaire Lumens : 16,503 lumens

POLAR CANDELA DISTRIBUTION

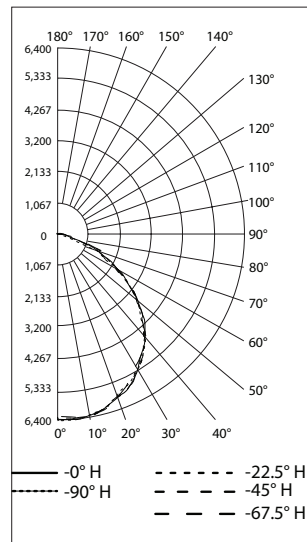

Industrial Areamaster™ Generation 2 and High Lumen LED Series Luminaires

Floodlight

Ordinary Locations

NEC/CEC/NOM: Type 3R, 4, 4X | IP66/67 | Marine outside type (salt water) for USA Only | Wet locations

IECEE CB: IK08 | IP66

Markings: CE | UKCA

Note: American Bureau of Shipping (ABS) Certified | 10G Vibration

Photometric Data — DATA SHOWN IS ABSOLUTE

NEMA 7x6, Clear Glass, 5000K CCT

REPORT NUMBER : IAMLGL6CG7BU

Luminaire Lumens : 9,086 lumens

POLAR CANDELA DISTRIBUTION

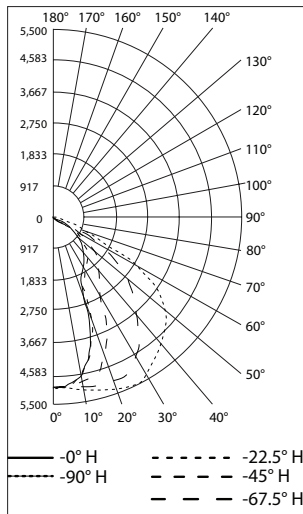

NEMA 7x6, Clear Glass, 3000K CCT

REPORT NUMBER : IAMLGL6WG7BU

Luminaire Lumens : 8,111 lumens

POLAR CANDELA DISTRIBUTION

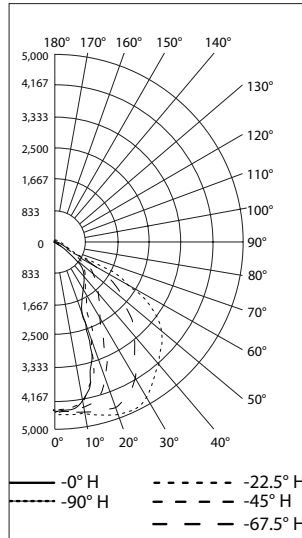

NEMA 7x6, Clear Glass, 5000K CCT

REPORT NUMBER : IAMLGL7CG7BU

Luminaire Lumens : 14,205 lumens

POLAR CANDELA DISTRIBUTION

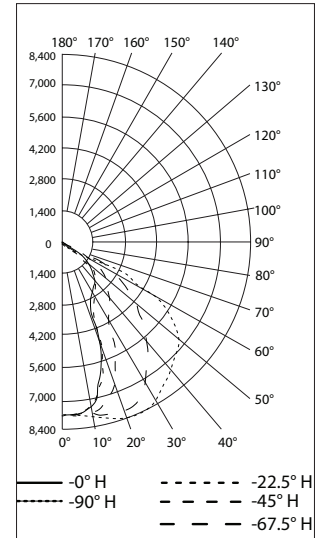

NEMA 7x6, Clear Glass, 3000K CCT

REPORT NUMBER : IAMLGL7WG7BU

Luminaire Lumens : 11,971 lumens

POLAR CANDELA DISTRIBUTION

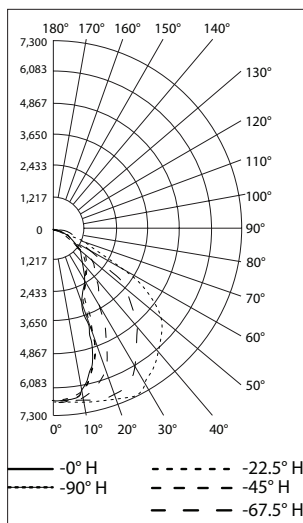

NEMA 7x6, Clear Glass, 5000K CCT

REPORT NUMBER : IAMLGL8CG7BU

Luminaire Lumens : 18,467 lumens

POLAR CANDELA DISTRIBUTION

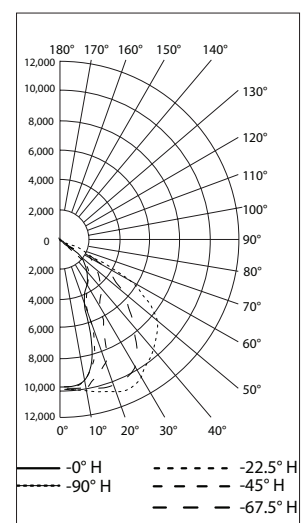

NEMA 7x6, Clear Glass, 3000K CCT

REPORT NUMBER : IAMLGL8WG7BU

Luminaire Lumens : 15,556 lumens

POLAR CANDELA DISTRIBUTION

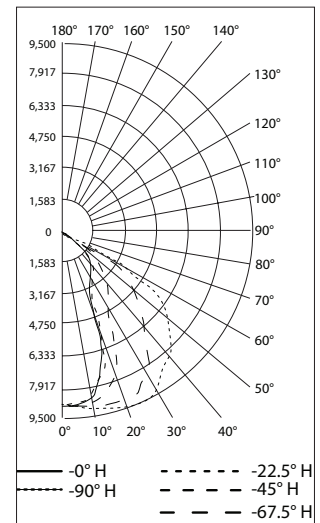

Industrial Areamaster™ Generation 2 and High Lumen LED Series Luminaires

Floodlight
Ordinary Locations

NEC/CEC/NOM: Type 3R, 4, 4X | IP66/67 | Marine outside type (salt water) for USA Only | Wet locations
IECEE CB: IK08 | IP66
Markings: CE | UKCA
Notable: American Bureau of Shipping (ABS) Certified | 10G Vibration

Photometric Data — DATA SHOWN IS ABSOLUTE

NEMA 5x5, Clear Glass, 5000K CCT
REPORT NUMBER : **IAMLHL1CG5BU**
Luminaire Lumens : 24,140 lumens
POLAR CANDELA DISTRIBUTION

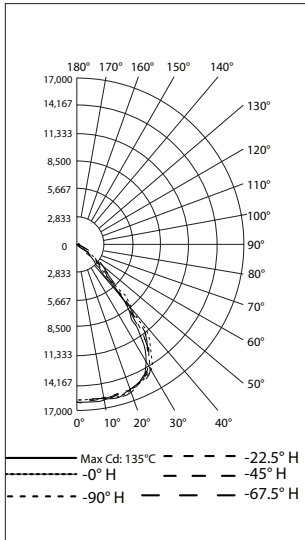

NEMA 5x5, Clear Glass, 3000K CCT
REPORT NUMBER : **IAMLHL1WG5BU**
Luminaire Lumens : 21,416 lumens
POLAR CANDELA DISTRIBUTION

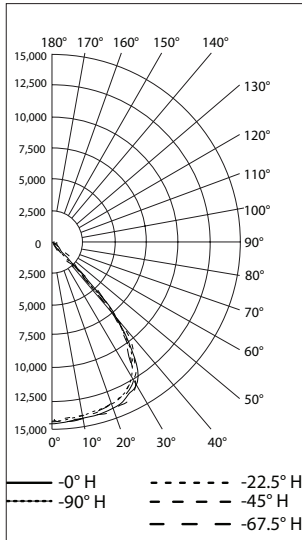

NEMA 5x5, Clear Glass, 5000K CCT
REPORT NUMBER : **IAMLHL2CG5BU**
Luminaire Lumens : 30,068 lumens
POLAR CANDELA DISTRIBUTION

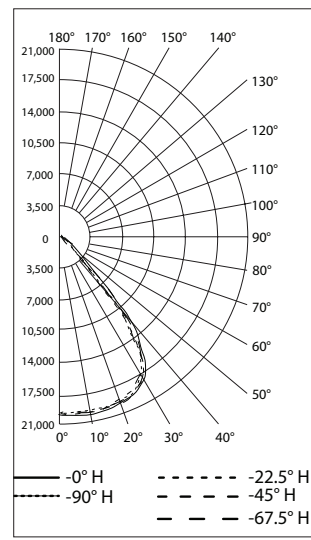

NEMA 5x5, Clear Glass, 3000K CCT
REPORT NUMBER : **IAMLHL2WG5BU**
Luminaire Lumens : 25,490
POLAR CANDELA DISTRIBUTION

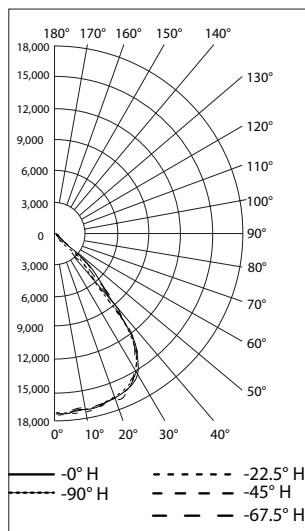

NEMA 5x5, Clear Glass, 5000K CCT
REPORT NUMBER : **IAMLHL3CG5BU**
Luminaire Lumens : 38,350 lumens
POLAR CANDELA DISTRIBUTION

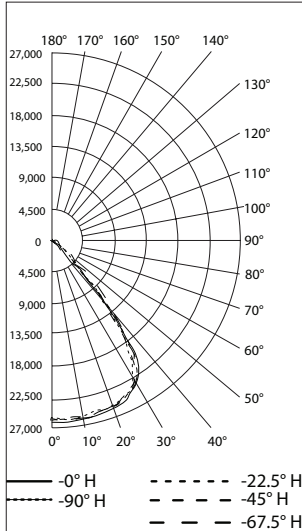

NEMA 5x5, Clear Glass, 3000K CCT
REPORT NUMBER : **IAMLHL3WG5BU**
Luminaire Lumens : 32,835 lumens
POLAR CANDELA DISTRIBUTION

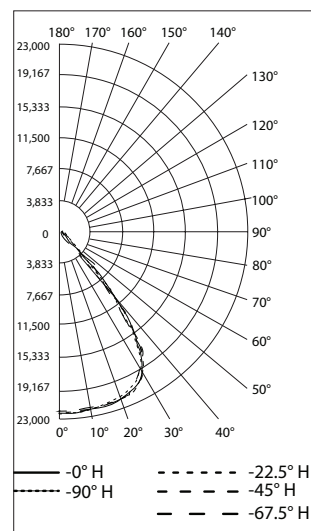

Industrial Areamaster™ Generation 2 and High Lumen LED Series Luminaires

Floodlight

Ordinary Locations

NEC/CEC/NOM: Type 3R, 4, 4X | IP66/67 | Marine outside type (salt water) for USA Only | Wet locations

IECEE CB: IK08 | IP66

Markings: CE | UKCA

Notable: American Bureau of Shipping (ABS) Certified | 10G Vibration

Photometric Data — DATA SHOWN IS ABSOLUTE

NEMA 7x6, Clear Glass, 5000K CCT

REPORT NUMBER : IAMLHL1CG7BU

Luminaire Lumens : 22,661 lumens

POLAR CANDELA DISTRIBUTION

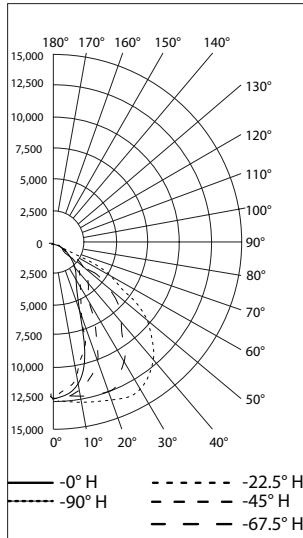

NEMA 7x6, Clear Glass, 3000K CCT

REPORT NUMBER : IAMLHL1WG7BU

Luminaire Lumens : 19,753

POLAR CANDELA DISTRIBUTION

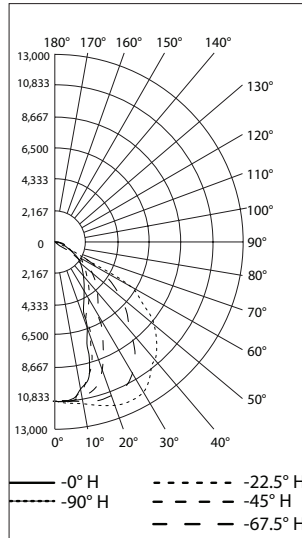

NEMA 7x6, Clear Glass, 5000K CCT

REPORT NUMBER : IAMLHL2CG7BU

Luminaire Lumens : 28,063 lumens

POLAR CANDELA DISTRIBUTION

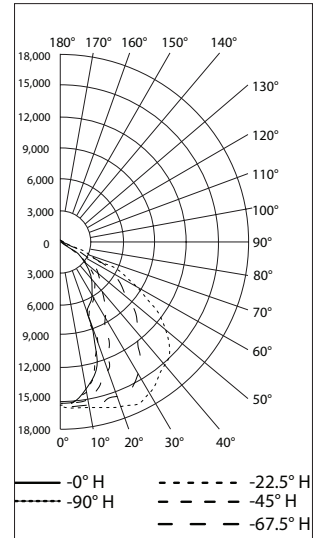

NEMA 7x6, Clear Glass, 3000K CCT

REPORT NUMBER : IAMLHL2WG7BU

Luminaire Lumens : 23,532 lumens

POLAR CANDELA DISTRIBUTION

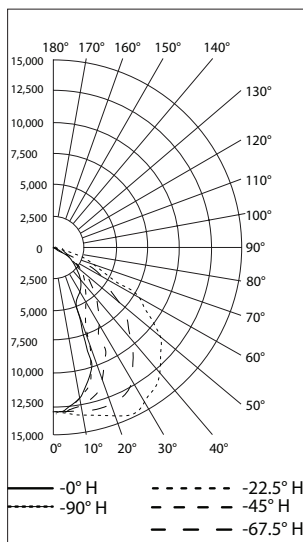

NEMA 7x6, Clear Glass, 5000K CCT

REPORT NUMBER : IAMLHL3CG7BU

Luminaire Lumens : 35,430 lumens

POLAR CANDELA DISTRIBUTION

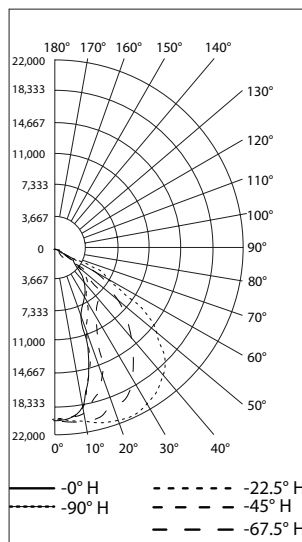

NEMA 7x6, Clear Glass, 3000K CCT

REPORT NUMBER : IAMLHL3WG7BU

Luminaire Lumens : 30,346 lumens

POLAR CANDELA DISTRIBUTION

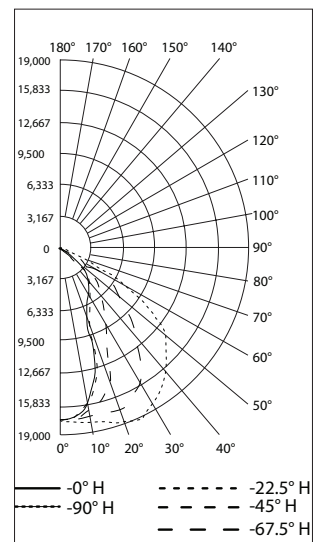

Industrial Areamaster™ Generation 2 and High Lumen LED Series Luminaires

Floodlight
Ordinary Locations

NEC/CEC/NOM: Type 3R, 4, 4X | IP66/67 | Marine outside type (salt water) for USA Only | Wet locations
IECEE CB: IK08 | IP66
Markings: CE | UKCA
Notable: American Bureau of Shipping (ABS) Certified | 10G Vibration

Photometric Data — DATA SHOWN IS ABSOLUTE

NEMA 7x7, Frosted Glass, 5000K CCT
REPORT NUMBER : **IAMLHL1CF6BU**
Luminaire Lumens : 20,578 lumens
POLAR CANDELA DISTRIBUTION

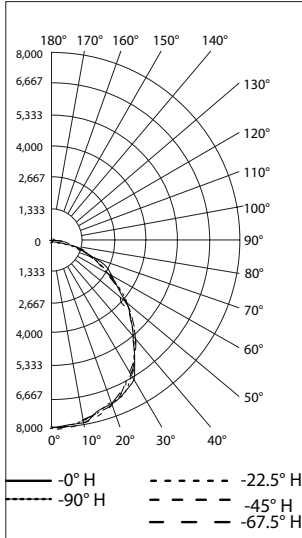

NEMA 7x7, Clear Glass, 5000K CCT
REPORT NUMBER : **IAMLHL1CG6BU**
Luminaire Lumens : 23,457 lumens
POLAR CANDELA DISTRIBUTION

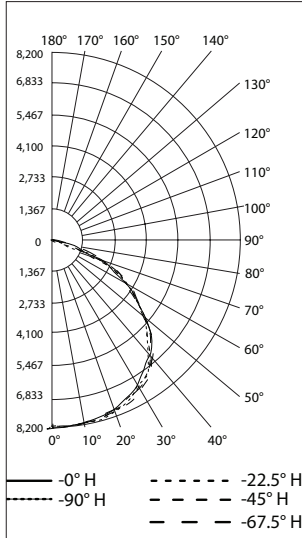

NEMA 7x7, Frosted Glass, 5000K CCT
REPORT NUMBER : **IAMLHL2CF6BU**
Luminaire Lumens : 25,616 lumens
POLAR CANDELA DISTRIBUTION

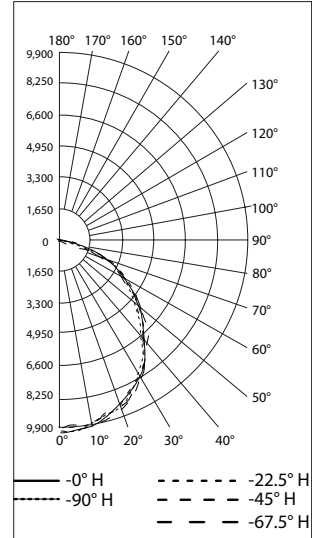

NEMA 7x7, Clear Glass, 5000K CCT
REPORT NUMBER : **IAMLHL2CG6BU**
Luminaire Lumens : 30,157 lumens
POLAR CANDELA DISTRIBUTION

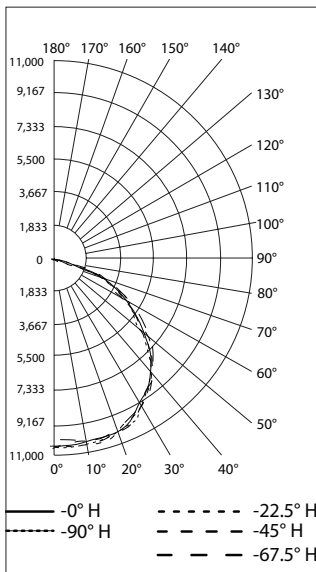

NEMA 7x7, Frosted Glass, 5000K CCT
REPORT NUMBER : **IAMLHL3CF6BU**
Luminaire Lumens : 31,600 lumens
POLAR CANDELA DISTRIBUTION

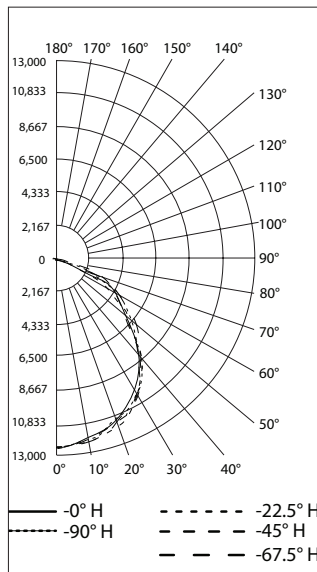

NEMA 7x7, Clear Glass, 5000K CCT
REPORT NUMBER : **IAMLHL3CG6BU**
Luminaire Lumens : 37,039 lumens
POLAR CANDELA DISTRIBUTION

