

ATX™ SWD Series 20 to 250 Amp Isolator Switches

Flameproof

Type CF2D | ATEX: Zones 1 and 2 – 21 and 22
Type CF2 | ATEX/IECEX: Zones 1 and 2 – 21 and 22

Applications

- Designed to prevent operation in explosive atmospheres during connect and disconnect operation of power loads.
- For use in hazardous areas where ignitable vapors, gases or highly combustible dusts are present.
- For installation in chemical and petrochemical plants, refineries and other process industries.

Features

- Available up to 690 Volts, and up to 250 Amps.
- Padlockable handle in position “O”.
- 3 or 4-pole switch mechanism.
- “NO-NC” early break auxiliary contact.
- Main contact termination: Up to 85 mm² (0.2868 in²).
- Auxiliary contact termination: 2.5 mm² (0.004 in²).
- Threaded cable entries: two at bottom and one at top – M20 to M63.
- Supplied with:
 - 1 x M20 blanking plug
 - 1 x M8 earth stud

Standard Materials

- Box: marine grade aluminum alloy
- Captive screws: A4 stainless steel

Standard Finishes

- Box: gray paint

Options

- Visible break assembly including a window to view power connection (only for 100 A to 160 A versions).

ATEX Certifications and Compliances

- Certification Type: CF2D
 - Gas: Zone 1 and 2
 - Conforming to ATEX 2014/34/EU: Ⓢ II 2 G
 - Type of Protection: Ex d IIB
 - Temperature Class: T6 for Ta ≤ +40 °C (+104 °F); T5 for +40 °C (+104 °F) < Ta ≤ +55 °C (+131 °F)
 - Dust: Zone 21 and 22
 - Conforming to ATEX 2014/34/EU: Ⓢ II2 D
 - Type of Protection: Ex tD A21
 - Surface Temperature: T95 °C (T203 °F)
 - Ambient Temperature: -40 °C to +55 °C (-40 °F to +131 °F)
 - ATEX Certificate: LCLCIE 02 ATEX 6061X
- Certification Type: CF2
 - Gas: Zone 1 and 2
 - Conforming to ATEX 2014/34/EU: Ⓢ II 2 G
 - Type of protection: Ex d IIB
 - Temperature Class: T6
 - Dust: Zone 21 and 22
 - Conforming to ATEX 2014/34/EU: Ⓢ II2 D
 - Type of Protection: Ex tD A21
 - Surface Temperature: T80 °C (T176 °F)
 - Ambient Temperature: -40 °C to +55 °C (-40 °F to +131 °F); CF10B is -20 °C to +55 °C (-4 °F to +131 °F)
 - ATEX Certificate: LCIE 02 ATEX 6057X
 - IECEx Certificate: 08 0023X
- Index of Protection according EN/IEC 60529: IP66
- Impact Resistance (shock): IK10

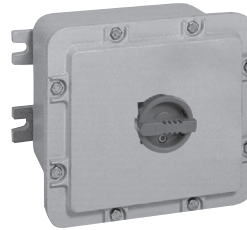

63 Amp Version



63 Amp Version
Visible Break Assembly

ATX™ SWD Series 20 to 250 Amp Isolator Switches

Flameproof

Type CF2D | ATEX: Zones 1 and 2 – 21 and 22
 Type CF2 | ATEX/IECEX: Zones 1 and 2 – 21 and 22

Catalog Numbering Guide

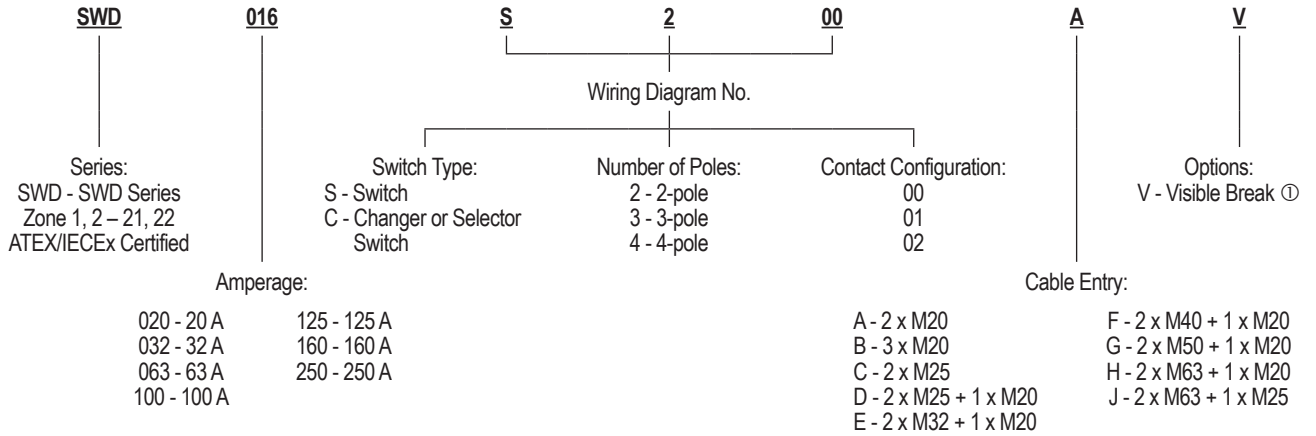

Switching Arrangement — X Denotes "Closed Contact"

S300

Positions	Contacts		
	1-2	3-4	5-6
0			
1	X	X	X

S400

Positions	Contacts			
	1-2	3-4	5-6	7-8
0				
1	X	X	X	X

⊕ For 100, 125 and 160 Amp versions only.

ATX™ SWD Series 20 to 250 Amp Isolator Switches

Flameproof

Type CF2D | ATEX: Zones 1 and 2 – 21 and 22
 Type CF2 | ATEX/IECEX: Zones 1 and 2 – 21 and 22

Switch Type	Wiring Diagram No.	Certified Type	Weight kg (lb)	Volume dm ³ (in ³)	Catalog Number
20 A – 3 x M20 threaded entries (1 Top and 2 Bottom)					
3-pole switch	S300	CF2D	3.8 (0.15)	11 (671.3)	SWD020S300B
4-pole switch	S400	CF2D	3.8 (0.15)	11 (671.3)	SWD020S400B
32 A – Bottom entries: 1 x M25 + 1 x M20 – Top entries: 1 x M25					
3-pole switch	S300	CF2D	3.8 (8.377)	11 (671.3)	SWD032S300D
3-pole switch + visible break	S400	CF20B	15 (33.07)	24.5 (1495.1)	SWD032S300DV
4-pole switch	S300	CF10B	11 (24.25)	19.6 (1196.1)	SWD032S400D
4-pole switch + visible break	S400	CF20B	15 (33.07)	24.5 (1495.1)	SWD032S400DV
63 A – Bottom entrie: 1 x M32 + 1 x M20 – Top entries: 1 x M32					
3-pole switch	S300	CF10B	11 (24.25)	19.6 (1196.1)	SWD063S300E
3-pole switch + visible break	S400	CF20B	15 (33.07)	24.5 (1495.1)	SWD063S300EV
4-pole switch	S300	CF10B	11 (24.25)	19.6 (1196.1)	SWD063S400E
4-pole switch + visible break	S400	CF20B	15 (33.07)	24.5 (1495.1)	SWD063S400EV
100 A – Bottom entries: 1 x M40 + 1 x M20 – Top entries: 1 x M40					
3-pole switch	S300	CF20B	13 (0.51)	24.5 (1495.1)	SWD100S300F
4-pole switch	S400	CF20B	13 (0.51)	24.5 (1495.1)	SWD100S400F
125 A – Bottom entries: 1 x M50 + 1 x M20 – Top entries: 1 x M50					
3-pole switch	S300	CF20B	13 (28.66)	24.5 (1495.1)	SWD125S300G
3-pole switch + visible break	S400	CF40B	52 (114.64)	235.2 (14352.8)	SWD125S300GV
4-pole switch	S300	CF20B	13 (28.66)	24.5 (1495.1)	SWD125S400G
4-pole switch + visible break	S400	CF40B	52 (114.64)	235.2 (14352.8)	SWD125S400GV
160 A – Bottom entries: 1 x M50 + 1 x M20 – Top entries: 1 x M50					
3-pole switch	S300	CF40B	50.5 (110.23)	235.2 (14352.8)	SWD160S300G
3-pole switch + visible break	S400	CF40B	52 (114.64)	235.2 (14352.8)	SWD160S300GV
4-pole switch	S300	CF40B	50.5 (110.23)	235.2 (14352.8)	SWD160S400G
4-pole switch + visible break	S400	CF40B	52 (114.64)	235.2 (14352.8)	SWD160S400GV
250 A – Bottom entries: 1 x M63 + 1 x M20 – Top entries: 1 x M63					
3-pole switch	S300	CF60B	112 (4.41)	646.6 (39458.0)	SWD250S300H
4-pole switch	S400	CF60B	112 (4.41)	646.6 (39458.0)	SWD250S400H

ATX™ SWD Series 20 to 250 Amp Isolator Switches

Flameproof

Type CF2D | ATEX: Zones 1 and 2 – 21 and 22
 Type CF2 | ATEX/IECEx: Zones 1 and 2 – 21 and 22

Technical Data								
Main Contacts	20 Amps	32 Amps	63 Amps	100 Amps	125 Amps	160 Amps	250 Amps	
Rated Insulation Voltage (Ui)	800 V	800 V	800 V	800 V	800 V	800 V	800 V	800 V
Rated Operating Voltage (Ue)	415 V/500 V/ 690 V	415 V/500 V/ 690 V	415 V/500 V/ 690 V	415 V/500 V/ 690 V	415 V/500 V/ 690 V	415 V/500 V/ 690 V	415 V/500 V/ 690 V	415 V/500 V/ 690 V
Rated Operating Current (Ie)	25 A	32 A/32 A/ 25 A	63 A/63 A/ 40 A	100 A	125 A	160 A/160 A/ 125 A	250 A/250 A/ 200 A	
Rated Surge Voltage (Uimp)	8 kV	8 kV	8 kV	8 kV	8 kV	8 kV	8 kV	8 kV
Short Circuit Resistance	50 kA (with fuse)	50 kA (with fuse)	50 kA (with fuse)	100 kA (with fuse)	63 kA (with fuse)	80 kA (with fuse)	50 kA (with fuse)	
Switching Capacity								
AC 21 A	415 V	25 A	32 A	63 A	100 A	125 A	160 A	250 A
	500 V	25 A	32 A	63 A	100 A	125 A	160 A	250 A
	690 V	25 A	32 A	63 A	100 A	125 A	160 A	200 A
AC 22 A	415 V	25 A	32 A	63 A	100 A	125 A	160 A	250 A
	500 V	25 A	32 A	63 A	100 A	125 A	125 A	250 A
	690 V	25 A	32 A	63 A	63 A	80 A	100 A	125 A
AC 23 A	230 V	25 A	–	–	–	–	–	–
	415 V	25 A	32 A	63 A	100 A	125 A	125 A	250 A
	500 V	25 A	25 A	63 A	80 A	100 A	100 A	200 A
	690 V	25 A	25 A	40 A	63 A	80 A	80 A	100 A
AC 23 A Motor Power (kW)	230 V	–	–	–	–	–	–	–
	415 V	11 kW	15 kW	30 kW	45 kW	55 kW	75 kW	132 kW
	500 V	11 kW	15 kW	30 kW	45 kW	55 kW	75 kW	140 kW
	690 V	15 kW	18.5 kW	30 kW	45 kW	75 kW	75 kW	90 kW
DC 21	24/48 V, 25 A ①	–	–	–	–	–	–	220 V, 250 A ①
	–	–	–	–	–	800 V, 125 A ①	800 V, 125 A ①	440 V, 200 A ①
	–	–	–	–	–	–	–	500 V, 200 A ①
DC 22	–	–	–	–	–	–	–	220 V, 250 A ①
	–	–	–	–	–	–	–	440 V, 200 A ①
	–	–	–	–	–	–	–	500 V, 200 A ①
DC 23	–	–	–	–	–	–	–	220 V, 250 A ①
	–	–	–	–	–	–	–	440 V, 200 A ①
	–	–	–	–	–	–	–	500 V, 200 A ①
Flexible Termination	0.75 to 6 mm ² (0.001 to 0.009 in ²)	16 mm ² (0.025 in ²)	4 to 35 mm ² (0.006 to 0.054 in ²)	4 to 50 mm ² (0.006 to 0.078 in ²)	4 to 50 mm ² (0.006 to 0.078 in ²)	4 to 50 mm ² (0.006 to 0.078 in ²)	4 to 50 mm ² (0.006 to 0.078 in ²)	95 mm ² (0.147 in ²)
Solid Termination	10 mm ² (0.016 in ²)	16 mm ² (0.025 in ²)	50 mm ² (0.076 in ²)	70 mm ² (0.109 in ²)	70 mm ² (0.109 in ²)	70 mm ² (0.109 in ²)	70 mm ² (0.109 in ²)	150 mm ² (0.233 in ²)
Auxiliary Contacts								
Rated Operating Voltage (Ue)	230 V/400 V	250 V	250 V	250 V	250 V	250 V	250 V	230 V/400 V
Rated Operating Current (Ie)	6 A/4 A	5 A	5 A	5 A	5 A	5 A	5 A	4 A/3 A
Switching Capacity								
AC 15	6 A/230 V	5 A/250 V	5 A/250 V	5 A/250 V	5 A/250 V	5 A/250 V	5 A/250 V	4 A/230 V - 3 A/400 V
DC 14	–	–	–	–	–	–	–	1 A/24 V - 0.2 A/48 V
Flexible Termination	2.5 mm ² (0.004 in ²)	2.5 mm ² (0.004 in ²)	2.5 mm ² (0.004 in ²)	2.5 mm ² (0.004 in ²)	2.5 mm ² (0.004 in ²)	2.5 mm ² (0.004 in ²)	2.5 mm ² (0.004 in ²)	2.5 mm ² (0.004 in ²)

① Two contacts connected in series.

ATX™ SWD Series 20 to 250 Amp Isolator Switches

Flameproof

Type CF2D | ATEX: Zones 1 and 2 – 21 and 22
 Type CF2 | ATEX/IECEx: Zones 1 and 2 – 21 and 22

Dimensions in Millimeters (Inches)

CF2D

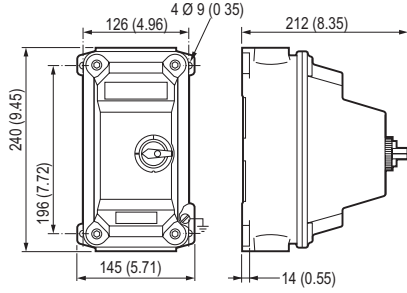

CF10B

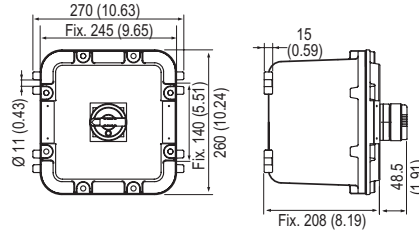

CF20B

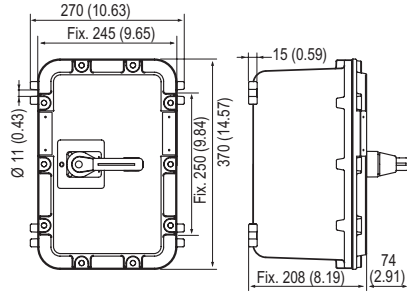

CF20B version à coupe visible

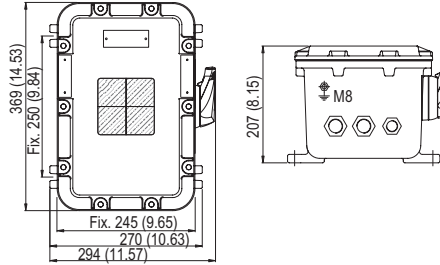

CF40B

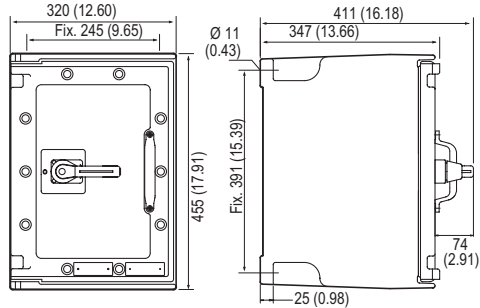

CF40B version à coupe visible

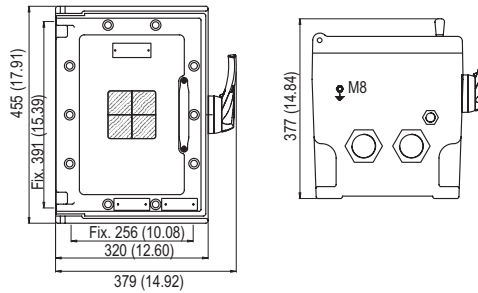

CF60B

